



HIGH PRECISION

TOOL-A-THON[®]

over
20 NEW
items!



Volume 20.3

~~Valid Jul. 1st - Sept. 30th~~

Valid Sept. 1st - Dec. 31st

www.fowlerprecision.com

X-TEST® Horizontal Indicators



NOW available
with High Contrast
Black Dial Face!



- Includes NIST certificate of calibration
- Solid brass body
- Super smooth jeweled movement
- Smoother bezel adjustment for easier zero setting
- 0.080" and 0.120" carbide ball contact points (0.040" steel ball)
- 0.060" range with auto reverse and rev. counter
- Easy to read tilted dial
- 5/32" pivotable stem



52-562-002-BF

Order No.	Dial Size	Dial Reading	Sale Price
52-562-001-BF	1-1/2"	0 - 15 - 0	Compare to Brown & Sharpe 74.111370 @ \$227.53 \$120.40
52-562-002-BF	1"	0 - 15 - 0	120.40

M5 Edge Finder



- With this tool edges can be detected with doors open and spindles off
- Solves safety door lock issues
- High repeatability and accuracy at 0.0005"
- Indicates centerline of spindle at 0.20" from edge
- Made from 4140 pre-hardened steel
- Easy viewing without obstruction of coolant covered windows

Order No. 52-575-150-0

Sale \$100.00

List \$116.20





Bluetooth Ultra-Cal VI Electronic Calipers



54-100-167-0

- IP67 rated
- Available with or without Bluetooth
- Heavy duty frame
- Extra large display
- NOW available with ISO Cert
- 12"/300mm is supplied without depth rod



LIFETIME WARRANTY



Order No.	Description	Accuracy	Resolution	Sale Price
Without Data Output				
54-100-177-0	6"/150mm	0.0008"/20µm	0.0005"/0.01mm	<i>Compare to Mitutoyo 500-196-30 @ \$119.00</i> \$108.90
54-100-178-0	8"/200mm	0.0012"/30µm	0.0005"/0.01mm	220.10
54-100-179-0	12"/300mm	0.0012"/30µm	0.0005"/0.01mm	298.00
Bluetooth				
54-100-167-0	6"/150mm	0.0008"/20µm	0.0005"/0.01mm	\$313.20
54-100-167-C	6"/150mm <i>with ISO/A2LA Certification</i>			342.20
54-100-168-0	8"/200mm	0.0012"/30µm	0.0005"/0.01mm	581.40
54-100-169-0	12"/300mm	0.0012"/30µm	0.0005"/0.01mm	774.60
Accessory				
54-115-246-BT	USB bluetooth receiver			\$45.80

Ultra-Cal VI Proximity Electronic Calipers



54-100-444-1

- IP67 rated
- Ultra-Cal VI technology with proximity cable data output
- Heavy duty frame
- Extra large display
- 12"/300mm is supplied without depth rod

LIFETIME WARRANTY



Order No.	Description	Accuracy	Resolution	Sale Price
54-100-444-1	6"/150mm	0.0008"/20µm	0.0005"/0.01mm	<i>Compare to Mitutoyo 500-171-30 @ \$165.87</i> \$146.70
54-100-448-1	8"/200mm	0.0012"/30µm	0.0005"/0.01mm	264.90
54-100-412-1	12"/300mm	0.0012"/30µm	0.0005"/0.01mm	354.70
Connectivity Cables				
54-115-526-0	Proximity cable with USB connection			\$135.00
54-155-527-0	Proximity cable with serial connection			135.00

Fowler

TOOL-A-THON®

2020

Find us on social media!

Ultra-Cal V Electronic Calipers

Buy 5, Get 1 FREE!



54-100-067-1

- 4-way measurement, inside, outside, depth and step (6" & 8" models)
- Hardened stainless steel construction
- Direct RS232 output
- Features Absolute/Relative Measuring Modes
- Thumbroll (6" and 8" models only)
- NOW available with ISO Cert
- 12"/300mm is supplied without depth rod

LIFETIME WARRANTY



IP67



Order No.	Description	Accuracy	Resolution	List Price	Sale Price
54-100-067-1	6"/150mm	0.0008"/20µm	0.0005"/0.01mm	\$229.57	\$130.00
54-100-067-C	6"/150mm <i>with ISO/A2LA Certification</i>				159.00
54-100-069-1	12"/300mm	0.0012"/30µm	0.0005"/0.01mm	459.00	365.00
Connectivity Cables					
54-115-526-0	Proximity cable with USB connection			\$143.00	\$135.00
54-115-527-0	Proximity cable with serial connection			143.00	135.00

Micron 0.00005" Electronic Caliper



*caliper sold with thumbroll feature



LIFETIME WARRANTY



IP67

- Bluetooth connectivity
- High resolution: 0.00005"/0.001mm
- Accuracy up to 4": 0.0006"/0.015mm
- Accuracy above 4": 0.0012"/0.03mm
- Repeatability: 0.00016"/0.004mm
- 4-way measuring, inside, outside, depth and step
- Heavy duty frame (3.5mm)

Order No.	Description	List Price	Sale Price
54-100-100-0	6"/150mm Micron Electronic Caliper	\$404.10	\$360.00
Accessory			
54-115-246-BT	USB bluetooth receiver	\$50.80	\$45.80

IP67

PLUS+

Electronic Calipers

with Smart Wireless Communication



54-100-556-BT

IP67

IP67 & Smart Wireless All in one!



- **NEW** HID Interface allows connection to most bluetooth enabled devices
- Includes an extra battery tray and a 1" setting standard
- Supplied with NIST certification
- Heavy duty frame with 4-way measuring, inside, outside, depth and step
- Super large display
- Wireless connectivity in a value priced electronic caliper
- Protected to IP67

Order No.	Range	Accuracy		Sale Price
54-100-554-BT	0 - 4"/100mm	0.001"/0.02mm	Compare to Mitutoyo 500-762-20 @ \$237.59	\$145.50
54-100-556-BT	0 - 6"/150mm	0.001"/0.02mm		149.60
54-100-558-BT	0 - 8"/200mm	0.0015"/0.04mm		181.90

Water Resistant IP54 Electronic Calipers

Absolute Reading!



54-100-777-2

- Absolute sensor technology
- 4-way measuring, inside, outside, depth and step
- Stainless steel frame
- Resolution: 0.0005"/0.01mm



Order No.	Range	Accuracy	List Price	Sale Price
54-100-777-2	0 - 6"/150mm	0.0015"/0.04mm	\$161.70	\$132.30
54-100-712-2	0 - 12"/300mm	0.0015"/0.04mm	235.18	171.10
Accessory				
54-115-100-0	Wireless Transmitter		\$123.09	\$100.00

Prices & Specifications are subject to change without notice.

EURO-CAL IV® Electronic Calipers



54-100-330-1



INCH • METRIC • FRACTION™

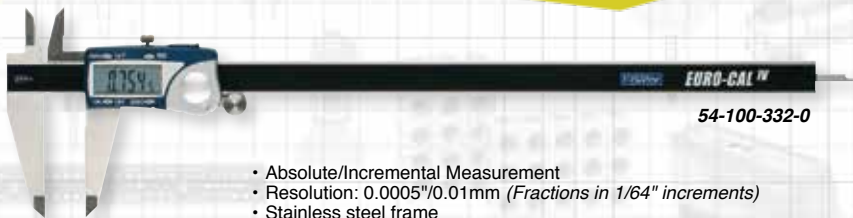

54-100-332-0

- Absolute/Incremental Measurement
- Resolution: 0.0005"/0.01mm (*Fractions in 1/64" increments*)
- Stainless steel frame
- 4-way measuring, inside, outside, depth and step

Order No.	Range	Accuracy	List Price	Sale Price
54-100-330-1	6"/150mm	± 0.001"/0.02mm	\$146.96	\$120.00
54-100-331-0	8"/200mm	± 0.001"/0.02mm	173.91	126.50
54-100-332-0	12"/300mm	± 0.0015"/0.03mm	223.08	182.60

Digital Calipers



54-100-004-2

Absolute Reading!



54-100-000-2

- Resolution: 0.0005"/0.01mm
- Absolute/Incremental Measurement
- Stainless steel frame
- Direct Inch/Metric conversion
- Large easy-to-read LCD display
- Absolute referencing
- Includes case



Order No.	Range	Accuracy		Sale Price
54-100-004-2	0 - 4"/100mm	0.001"/0.02mm		\$101.10
54-100-000-2	0 - 6"/150mm	0.001"/0.02mm	Compare to Mitutoyo 500-196-30 @ \$141.40	117.90
54-100-008-2	0 - 8"/200mm	0.0015"/0.04mm		138.40
54-100-112-2	0 - 12"/300mm	0.0015"/0.04mm		180.40
Accessories				
54-115-100-0	Wireless transmitter			100.00
54-520-399-0	SPC cable (USB)			137.60

XTRA-VALUE CAL Electronic Calipers

Buy a 12" Get a 6" FREE

Buy a 12" (54-101-300-1) at **list price** and get a 6" (54-101-150-2) **FREE**



"Great price,
good quality, prompt
processing"

Terri F.

- Accuracy: 0.001"/0.02mm (6" models)
- Stainless steel frame
- Large easy-to-read display
- Resolution: 0.0005"/0.01mm
- Absolute/Incremental Measurement
- 4-way measuring, inside, outside, depth and step



Order No.	Range	Display Type	List Price	Sale Price
54-101-300-P	Buy a 12" (54-101-300-1) and Get a 6" (54-101-150-2) FREE		\$169.07	\$112.64
54-101-150-2	6"/150mm	Regular Display - includes FREE NIST Cert.	56.43	46.20
54-101-600-1	6"/150mm	Super Large Display with hold feature	73.59	60.30
54-101-800-1	8"/200mm	Super Large Display with hold feature	110.22	90.20
54-101-300-1	12"/300mm	Regular Display - includes FREE NIST Cert.	112.64	92.20
54-101-900-1	12"/300mm	Super Large Display with hold feature	147.18	120.50

XTRA-VALUE Plus Electronic Caliper

INCH • METRIC • FRACTION™



- Range: 0 - 12"/300mm
- Accuracy: ± 0.0015"/0.04mm, resolution: 0.0005"/0.01mm
- Inch/Metric/Fraction reading: 0.0005"/0.01mm/ 1/128"
- Dust, water and oil resistant to IP54 standards making it **great for shop environments**
- Heavy Duty frame for extra rigidity and wear resistance
- Super large, easy to read 14 x 52mm display
- Combined thumbrest and thumbroll for fine adjustment



Order No. **54-103-012-0**

Sale \$124.00

List \$150.04

Prices & Specifications are subject to change without notice.

7

Fowler

TOOL-A-THON®

2020

Find us on social media!

f E in YouTube

Machinist Grade Dial Calipers



52-008-706-0



“Very precise with consistent readings. I would never change this analog for a digital one.”
 Erick T.

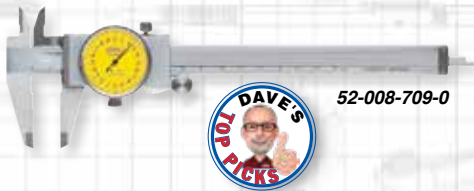

52-008-709-0



- 4-way measuring, inside, outside, depth and step
- Solid stainless steel construction
- 0.100"/2mm range per revolution
- 0.001"/0.02mm reading dial face
- Tough shockproof gearing

Order No.	Range	Dial Face Color	Accuracy		Sale Price
52-008-706-0	0 - 6"	White	± 0.001"		\$83.00
52-008-707-0	0 - 6"	Black	± 0.001"		83.00
52-008-708-0	0 - 8"	White	± 0.0015"		80.50
52-008-712-0	0 - 12"	White	± 0.002"	Compare to Mitutoyo 505-746 @ \$230.00	119.90
52-008-709-0	0 - 150mm	Yellow	± 0.02mm		83.00

0 - 6" Dial Calipers



52-008-005-0



52-008-007-0

- 4-way measuring, inside, outside, depth and step
- Covered rack
- Accuracy ± 0.001"
- 0.100" per revolution
- Dial graduation: 0.001"
- Hardened stainless steel rack

Order No.	Range	Dial Face Color	Accuracy	List Price	Sale Price
52-008-005-0	0 - 6"/150mm	Black	± 0.001"	\$103.73	\$78.90
52-008-007-0	0 - 6"/150mm	White	± 0.001"	96.36	78.90

Dial Cal Plus Dial Calipers



52-008-050-0



- 4-way measuring, inside, outside, depth and step
- 0.100" per revolution
- Thumbroll for fine adjustment
- Carriage lock screw
- Heavy duty stainless steel frame - 4mm thick
- Adjustable bezel with lock

Order No.	Description	Accuracy	Graduation	List Price	Sale Price
52-008-050-0	0 - 6" - white dial face	± 0.001"	0.001"	\$139.70	\$110.00
52-008-051-0	0 - 6" - black dial face	± 0.001"	0.001"	139.70	110.00

Premium Dial Caliper

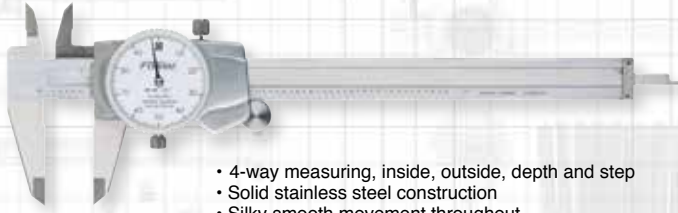

- 4-way measuring, inside, outside, depth and step
- Solid stainless steel construction
- Silky smooth movement throughout
- 0 - 6" range, 0.100" per revolution, 0.001" graduations
- Thumbroll for rapid setting
- Knurled lock assures precise settings

Order No. **52-008-006-2**

Compare to Mitutoyo 505-742 @ \$109.67

Sale \$90.00



Inch/Metric Reading Dial Calipers



6" caliper shown

- Dial face reads in both inch (black) and metric (red)
- Hardened stainless steel throughout
- 4-way measuring, inside, outside, depth and step
- Raised sliding surface prevents wear and defacement of graduations
- Covered stainless steel rack

Order No.	Range	Graduation	Accuracy	List Price	Sale Price
52-030-008-0	0 - 8"/200mm	0.001"/0.02mm	± 0.0015"	\$138.71	\$110.00
52-030-012-0	0 - 12"/300mm	0.001"/0.02mm	± 0.002"	186.34	150.00

Vernier Calipers

- Made of fully hardened stainless steel; microfine black graduations on a satin chrome finish for easy, precise reading
- All models offer a depth rod which can be read directly from verniers
- Measuring faces are ground and lapped for extreme accuracy
- 4-way measuring, inside, outside, depth and step
- All sliding surfaces are raised to prevent defacement and wear of graduations

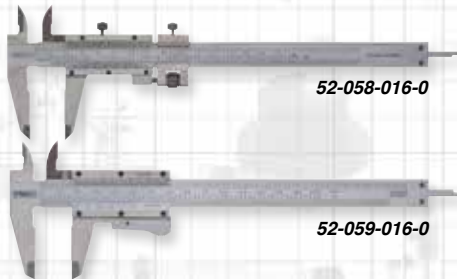

52-058-016-0

52-059-016-0

Order No.	Range	Graduation	Depth of Jaws	List Price	Sale Price
Vernier Caliper with Fine Adjustment					
52-058-016-0	0 - 6"/0 - 150mm	0.001"/0.02mm	1.6"	\$57.53	\$47.10
Vernier Caliper with Thumb Lock					
52-059-016-0	0 - 6"/0 - 150mm	0.001"/0.02mm	1.6"	51.92	42.00

Prices & Specifications are subject to change without notice.

Extended Range Dial Calipers



52-008-018-0

- Graduations: 0.001"
- Jaw depth: 3.375"
- Stainless steel construction
- Satin chrome finish
- Depth rod
- 0.500" internal measuring nibs



Order No.	Range	Accuracy	Jaw Depth	List Price	Sale Price
52-008-018-0	18"	± 0.003"	3.125"	\$291.39	\$238.50
52-008-024-0	24"	± 0.003"	3.375"	353.10	288.90

XTRA-RANGE® Electronic Calipers

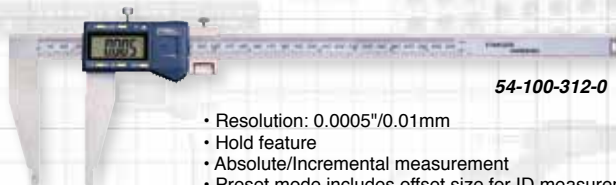

54-100-312-0

- Resolution: 0.0005"/0.01mm
- Hold feature
- Absolute/Incremental measurement
- Preset mode includes offset size for ID measurements
- All sizes feature fine adjustment screw
- Includes shop hardened case



Order No.	Range	Accuracy	Jaw Depth	Sale Price
54-100-312-0	12"/300mm	± 0.002"	3.5"	\$183.10
54-100-024-1	24"/600mm	± 0.003"	4"	303.10
54-100-042-1	40"/1000mm	± 0.004"	4.9"	902.50

Compare to Mitutoyo 550-225-10 @ \$1,035.00

Light Line Electronic Calipers



54-112-012-0

- Light weight beam made of oxide coated aluminum with double inner prismatic guide ways for optimal guidance and sliding characteristics
- Stainless steel jaws, hardened and finely ground with knife edge top jaws
- Jaws are adjustable and exchangeable
- Spare jaws can be modified and exchanged with standard jaws for special applications
- Both jaws are moveable to any position on the main beam
- Electronics feature on/off, floating zero and direct in/mm conversion
- 0.0005"/.01mm resolution and repeatability
- Includes a fitted case, instructions and test certificate



Made in GERMANY

Order No.	Range	Accuracy	List Price	Sale Price
54-112-012-0	0 - 12"/300mm	0.0015"/0.04mm	\$316.20	\$265.00
54-112-030-0	0 - 31"/800mm	0.002"/0.06mm	728.90	615.00
Accessory				
52-075-150-0	6" replacement jaws		\$107.20	\$96.00

Fowler-Sylvac Ultralight IV Electronic Calipers

The Fowler-Sylvac Ultralight IV, new design, new features, built-in Bluetooth transmitter. Discover our amazing Ultralight long range calipers.



- Built-in Bluetooth
- New reinforced frame
- XXL display with 0.79"/20mm high digits
- Increased accuracy
- Lengthened jaws 7.9"/200mm
- Includes upper ID measuring pins (5mm dia.)
- New system for internal measurement
- Protected to IP67
- Moveable left jaw
- Stainless steel titanium coated jaws
- Hold feature
- Preset function
- Min/Max functions
- Tolerance mode
- Internal and external measurement indicator
- New twin guided main beam



Alternative jaws available, contact the Fowler Technical Department for more information 1-800-788-2353

Specifications	54-110-512-0	54-110-524-0	54-110-540-0	54-110-560-0	54-110-580-0	54-110-600-0
Measuring Range	0-15"/0-400mm	0-24"/0-600mm	0-40"/0-1000mm	0-60"/0-1500mm	0-80"/0-2000mm	0-100"/0-2500mm
Maximum Error	30µm/0.0012"	40µm/0.0016"	50µm/0.002"	90µm/0.0035"	120µm/0.0048"	200µm/0.0078"
Repeatability	20µm/0.0008"			30µm/0.0012"		
Measuring Force	5 - 10 N					
Connection	Bluetooth Smart/Proxi. - RS-232 or - USB					
Protection Rating	IP67 (Electronic Module)					
Preset Max.	±9999.99 mm / ±399.9995 IN					
Weight	1.5 kg	1.6 kg	1.9 kg	2.3 kg	2.6 kg	2.9 kg

Order No.	Range	List Price	Sale Price
54-110-512-0	0 - 15"/0 - 400mm	\$2123.70	\$1850.00
54-110-524-0	0 - 24"/0 - 600mm	2478.90	2095.00
54-110-540-0	0 - 40"/0 - 1000mm	2853.00	2560.00
54-110-560-0	0 - 60"/0 - 1500mm	4289.40	3850.00
54-110-580-0	0 - 80"/0 - 2000mm - <i>special order</i>	5909.80	5200.00
54-110-600-0	0 - 100"/0 - 2500mm - <i>special order</i>	7141.30	6784.00
Connectivity Cables/Accessory			
54-115-526-0	Proximity USB Cable	\$143.00	\$135.00
54-115-527-0	Proximity Serial Cable	143.00	135.00
54-115-246-BT	USB Bluetooth Receiver	50.80	45.80

Prices & Specifications are subject to change without notice.

Caliper Jaw Attachments

Contacts sold separately!



52-249-010-0

- Clamps on to caliper jaws, allows attachment of standard micrometer anvils
- Used alone or in pairs
- Contacts can be mixed or offset for unique applications
- Max. caliper jaw thickness 0.135"
- Clamp made of stainless steel



Caliper shown not included

Order No.	Description	List Price	Sale Price
52-249-010-0	Caliper Jaw Attachment	\$42.90	\$38.60
52-249-001-0	Spline: 0.100" dia.	20.40	16.00
52-249-002-0	Knife: 0.188" x 0.031" tip, 30° taper	20.40	16.00
52-249-003-0	Super Spline: 0.050" dia.	20.40	16.00
52-249-004-0	Blade: 0.188" x 0.031"	20.40	16.00
52-249-005-0	Point: 0.020" tip, 30° taper	20.40	16.00
52-249-006-0	Disc: 0.500" dia.	24.20	18.00
52-249-007-0	Complete 7 piece Contact Set, includes 1 Ball Contact	71.40	55.00

Caliper and Height Gage Checker

Fowler's Setting Masters are quick, easy and extremely accurate. Each comes with a manufacturer's certificate of calibration and a wood case. Save time and money by calibrating your own measuring tools.

- Horizontal and vertical use
- Used for the calibration of height gages and calipers
- Scale on one side reads: 0.5", 2", 4", 6", 8", 10" and 12" for inside caliper measurements
- Scale on side reads: 1", 2", 4", 6", 8", 10" and 12" for height gage and caliper checking
- Accuracy: $\pm .0002"$

NOW available in 24" model - special order

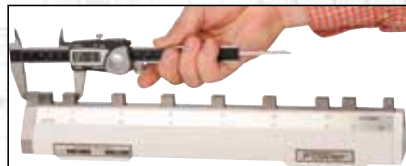

53-813-010-0

Order No.	Description	List Price	Sale Price
53-813-010-0	12" Caliper and Height Gage Checker	\$1613.60	\$1400.00
53-813-024-0	NEW 24" Caliper and Height Gage Checker	2121.00	1850.00

Rapid-Mic Quick-Displacement Electronic Micrometers



54-815-030-C

**WORLD'S FINEST
Micrometer!**



Contact the Fowler Sales Department
1-800-788-2353



"I have been in the machining business for over 30 years this is by far the best mic I have ever had. One little thing or should I rephrase that, one huge thing, this mic comes with a lifetime warranty... no other company can provide that!"

John T.

NEW Bluetooth Ranges NOW Available!

- Position recall
- Delrin quick displacement thimble
- Adjustable measuring force, 5N/10N (54-815-030-0 only)
- Menu customizable with free software
- Non-rotating spindle with 10mm spindle travel per thimble rotation
- USB output or bluetooth available



54-815-111-0



Order No.	Description	Max Error		Sale Price
54-815-030-0	0 - 1.18"/0 - 30mm	0.00012"/0.003mm	Compare to Mitutoyo 293-676-20 @ \$560.00	\$486.90
54-815-030-C	1.18"/30mm with ISO/A2LA Certification			511.90
54-815-060-0	1.18" - 2.6"/30 - 66mm	0.00016"/0.004mm		720.50
54-815-100-0	2.6" - 4.0"/66 - 102mm	0.00020"/0.005mm		1007.60
Set				
54-815-111-0	0 - 4"/0 - 102mm			2197.00
Bluetooth Model				
54-815-130-0	0 - 1.18"/0 - 30mm	0.00012"/0.003mm		720.50
54-815-160-0	1.18" - 2.6"/30 - 66mm	0.00016"/0.004mm		953.40
54-815-110-0	2.6" - 4.0"/66 - 102mm	0.00020"/0.005mm		1240.90
Bluetooth Set				
54-815-112-0	0 - 4"/0 - 102mm			2724.70
Connectivity Cables/Accessory				
54-115-526-0	Proximity cable with USB connection			135.00
54-115-527-0	Proximity cable with serial connection			135.00
54-115-246-BT	USB Bluetooth receiver			45.80

Prices & Specifications are subject to change without notice.

13

Fowler

TOOL-A-THON®

2020



Find us on social media!

XTRA-MIC PLUS+ Electronic Micrometers



54-880-001-0

Great for Shop Environments!

- Corrosive resistant ratchet thimble (anodized aluminum)
- Super large LCD display, 14mm height
- Resolution: 0.00005"/0.001mm
- IP54 protected against fluid and dust
- Carbide tipped anvil and spindle
- SPC output
- Sizes over 1"/25mm include a calibration standard
- Includes fitted case



FREE!



Order No.	Range	Accuracy	List Price	Sale Price
54-880-001-0	NEW 0 - 1"/0 - 25mm	0.00016"/0.004mm	\$156.42	\$113.80
54-880-002-0	NEW 1 - 2"/25 - 50mm	0.00016"/0.004mm	180.29	131.20
54-880-003-0	NEW 2 - 3"/50 - 75mm	0.0002"/0.005mm	192.72	140.20
54-880-004-0	NEW 3 - 4"/75 - 100mm	0.0002"/0.005mm	220.99	160.80
Set				
54-880-103-0	NEW 0 - 3"/0 - 75mm		\$497.53	\$361.90
Accessory				
54-520-399-0	SPC cable		\$189.20	\$137.60

QuadraMic Electronic 4-way Reading Micrometers



54-866-001-0

**Micrometer reads 4 ways
for incredible versatility!**



Features two displays which enable the operator to read as a right or left-handed micrometer. Simply press a button to invert the display allowing the micrometer to be used for a variety of measuring positions.

- Large 4-way reading LCD display
- Automatic switch off
- Absolute measuring system
- Resolution: 0.00005"/0.001mm
- Friction thimble
- Direct RS 232 output
- Carbide measuring faces
- Includes case

Order No.	Range	Accuracy	List Price	Sale Price
54-866-001-0	0 - 1.2"/0 - 30mm	± 0.00016"/0.004mm	\$224.84	\$200.00
54-866-002-0	1 - 2.2"/25 - 55mm	± 0.00016"/0.004mm	292.71	250.00

Electronic Coolant Resistant Micrometers

Fowler

TOOL-A-THON®

2020

Find us on social media!



54-860-001-1

- Protected to IP54 specifications
- Automatic switch off
- Resolution: 0.00005"/0.001mm
- Carbide measuring faces
- Absolute & incremental modes
- Sizes over 1"/25mm include a calibration standard



Order No.	Range	Accuracy	Sale Price
54-860-001-1	0 - 1"/0 - 25mm	± 0.00016"/0.004mm	<i>Compare to INSIZE</i> 3101-25E @ \$135.50
54-860-002-1	1 - 2"/25 - 50mm	± 0.00016"/0.004mm	117.60
54-860-003-1	2 - 3"/50 - 75mm	± 0.0002"/0.005mm	128.30
54-860-004-1	3 - 4"/75 - 100mm	± 0.0002"/0.005mm	148.90
54-860-005-1	4 - 5"/100 - 125mm	± 0.00024"/0.006mm	167.00
54-860-006-1	5 - 6"/125 - 150mm	± 0.00024"/0.006mm	187.00
Set			
54-860-103-1	0 - 3"/0 - 75mm Set		\$334.10

XTRA-VALUE II Electronic Micrometers



54-870-001-0

- Resolution: 0.00005"/0.001mm
- Carbide measuring faces
- Absolute and incremental modes
- Ratchet thimble
- Sizes over 1"/25mm include a calibration standard



Order No.	Range	Accuracy	List Price	Sale Price
54-870-001-0	0 - 1"/0 - 25mm	± 0.00016"/0.004mm	\$110.20	\$80.20
54-870-002-0	1 - 2"/25 - 50mm	± 0.00016"/0.004mm	119.02	86.60
54-870-003-0	2 - 3"/50 - 75mm	± 0.0002"/0.005mm	134.86	98.10
54-870-004-0	3 - 4"/75 - 100mm	± 0.0002"/0.005mm	150.81	109.70
Set				
54-870-103-0	0 - 3"/0 - 75mm		\$295.20	\$236.20

Prices & Specifications are subject to change without notice.

Electronic IP54 Ball Anvil Micrometers



54-860-113-1

Absolute Reading!



- Ball anvil/flat spindle for measuring tubes or the insides of holes to outer edges
- Protected to IP54 specifications
- Large LCD display, 8.5mm
- Automatic switch off
- Resolution: 0.00005"/0.001mm
- Hardened steel measuring face
- Absolute & incremental modes
- Sizes over 1"/25mm include a calibration standard

Order No.	Range	Accuracy	List Price	Sale Price
54-860-113-1	0 - 1"/0 - 25mm	0.00016"/0.004mm	\$141.57	\$105.00
54-860-114-1	1 - 2"/25 - 50mm	0.00016"/0.004mm	165.77	124.00
54-860-115-1	2 - 3"/50 - 75mm	0.0002"/0.005mm	190.41	142.00
54-860-116-1	3 - 4"/75 - 100mm	0.0002"/0.005mm	214.50	160.00

Electronic IP54 Ball Anvil & Spindle Micrometers



54-860-211-1

Absolute Reading!



- Ball anvil and spindle for measuring special curved surfaces
- Protected to IP54 specifications
- Large LCD display, 8.5mm
- Automatic switch off
- Resolution: 0.00005"/0.001mm
- Hardened steel measuring face
- Absolute & incremental modes
- Sizes over 1"/25mm include a calibration standard

Order No.	Range	Accuracy	List Price	Sale Price
54-860-211-1	0 - 1"/0 - 25mm	0.00016"/0.004mm	\$154.22	\$115.00
54-860-212-1	1 - 2"/25 - 50mm	0.00016"/0.004mm	177.98	132.00
54-860-213-1	2 - 3"/50 - 75mm	0.0002"/0.005mm	203.39	151.00
54-860-214-1	3 - 4"/75 - 100mm	0.0002"/0.005mm	229.90	171.00

Point Anvil & Spindle Micrometers



Absolute Reading!



- 30° pointed anvil and spindle for measuring small grooves, key-ways, small flutes, and hard to reach dimensions
- Protected to IP54 specifications
- Large LCD Display, 8.5mm
- Automatic switch off
- Carbide measuring points
- Absolute & incremental modes
- Sizes over 1"/25mm include a calibration standard

Order No.	Range	Resolution	Accuracy	List Price	Sale Price
54-860-661-0	0 - 1"/0 - 25mm	0.00005"/0.001mm	0.00016"/0.004mm	\$205.26	\$150.00
54-860-662-0	1 - 2"/25 - 50mm	0.00005"/0.001mm	0.00016"/0.004mm	224.51	165.00
54-860-663-0	2 - 3"/50 - 75mm	0.00005"/0.001mm	0.0002"/0.005mm	251.13	185.00
54-860-664-0	3 - 4"/75 - 100mm	0.00005"/0.001mm	0.0002"/0.005mm	273.13	200.00

0.8"/20mm Point Spindle & Blade Anvil Micrometer



Absolute Reading!



- 60° pointed spindle with blade anvil for grooves and hard to reach dimensions
- Accuracy: 0.00016"/0.004mm
- Resolution: 0.00005"/0.001mm
- Protected to IP54 specifications
- Large LCD display, 8.5mm
- Automatic switch off
- Hardened steel measuring face
- Absolute & incremental modes

Order No. 54-860-671-0

Sale \$125.00

List \$171.27

Prices & Specifications are subject to change without notice.

Vernier Thread Micrometers



52-219-001-1

- 60° measuring anvils
- Painted enamel and heat insulated frame
- Positive spindle lock
- Graduation: 0.001"
- Ratchet thimble
- Sizes over 1"/25mm include a calibration standard

Order No.	Range	Thread Range	Accuracy		Sale Price
52-219-001-1	0 - 1"	64 - 5 TPI/0.4 - 5mm	0.00016"	Compare to Mitutoyo 126-137 @ \$412.94	\$81.00
52-219-002-1	1 - 2"	44 - 3.5 TPI/0.6 - 7mm	0.00016"		89.00
52-219-003-1	2 - 3"	24 - 3.5 TPI/1 - 7mm	0.0002"		99.40
52-219-004-1	3 - 4"	24 - 3.5 TPI/1 - 7mm	0.0002"		108.90

Electronic IP65 Thread Micrometers



54-219-001-0



- Water Resistant to IP65 specifications
- True inch/metric conversion
- 60° measuring anvils
- ABS/INC measuring mode
- Positive spindle lock
- Painted enamel and heat insulated frame
- Resolution: 0.00005"/0.001mm
- Friction thimble
- Sizes over 1"/25mm include a calibration standard

Order No.	Range	Thread Range	Accuracy	List Price	Sale Price
54-219-001-0	0 - 1"	64 - 5 TPI/0.4 - 5mm	± 0.00008"/0.002mm	\$248.60	\$216.00
54-219-002-0	1 - 2"	44 - 3.5 TPI/0.6 - 7mm	± 0.00008"/0.002mm	265.87	224.10
54-219-003-0	2 - 3"	24 - 3.5 TPI/1 - 7mm	± 0.00008"/0.002mm	283.25	238.50
54-219-004-0	3 - 4"	24 - 3.5 TPI/1 - 7mm	± 0.00012"/0.003mm	300.63	256.50

Deep Throat Electronic Micrometer



- Range: 0 - 1¹/₀ - 25mm
- Resolution: 0.00005"/0.001mm
- Flat anvil
- Accuracy: ± 0.00012"/0.003mm
- Throat depth: 6"
- ABS/INC modes
- Ratchet thimble and spindle lock
- The spindle thread is hardened, ground and lapped. The anvil and spindle are hardened and precision ground with microlap finish on carbide tipped measuring faces.
- Diameter of measuring faces = 0.256"
- Flatness: 0.00003"
- Parallelism: 0.00005"



Order No. 54-517-001-0

Sale \$220.00

List \$244.42

Deep Throat Vernier Micrometers

Fowler's "U"-frame Deep Throat Micrometers are available with depths of 6" and 12". Use Deep Throat Micrometers for taking accurate measurements of steel and plastic sheets and plates whenever a depth measurement of 2" to 12" is needed.

- Hammertone blue baked enamel frame
- Graduations are microfine on satin chrome finish for easy reading
- All models feature a ratchet stop thimble for exact and repetitive readings
- The spindle thread is hardened, ground and lapped. The anvil and spindle are hardened and precision ground with microlap finish on carbide tipped measuring faces.
- Diameter of measuring faces = 0.256"
- Positive lever locking clamp ensures reliable measurement at all times
- Wrench furnished with each micrometer for fast, easy zero adjustment on the sleeve
- Flatness: 0.00003"
- Parallelism: 0.00005"
- **52-517-612-1 supplied with a ball anvil**
- Includes case



52-517-611-1

Order No.	Range	Graduation	Accuracy	Anvil	Throat Depth	List Price	Sale Price
52-517-611-1	0 - 1"	0.0001"	0.00016"	Flat	6"	\$164.89	\$136.00
52-517-612-1	0 - 1"	0.0001"	0.0002"	Ball	11.875"	205.70	170.00

Prices & Specifications are subject to change without notice.

Outside Inch Micrometers



52-240-001-1



52-215-003-1

- Microfine graduations on satin chrome finish and carbide tipped measuring faces
- Diameter of measuring faces: 0.256"
- Graduation: 0.0001"
- Flatness: 0.00003"
- Positive lever locking clamp
- Spindle thread hardened, ground and lapped for ultimate accuracy
- Anvil & spindle hardened and precision ground with microlap finish on tips
- Includes a wrench and case
- Sizes over 1"/25mm include a calibration standard

Order No.	Range	Accuracy	Thimble	Sale Price
52-240-001-1	0 - 1"	± 0.00015"	Friction	<i>Compare to Brown & Sharpe 00180070 @ \$118.00</i> \$38.70
52-240-101-1	0 - 1"	± 0.00015"	Ratchet	38.70
52-240-102-1	1 - 2"	± 0.00015"	Ratchet	45.00
52-240-003-1	2 - 3"	± 0.0002"	Ratchet	52.50
52-240-004-1	3 - 4"	± 0.0002"	Ratchet	58.60
52-240-005-1	4 - 5"	± 0.00025"	Ratchet	64.90
52-240-006-1	5 - 6"	± 0.00025"	Ratchet	71.10
52-240-007-1	6 - 7"	± 0.0003"	Ratchet	77.40
52-240-008-1	7 - 8"	± 0.0003"	Ratchet	91.00
52-240-009-1	8 - 9"	± 0.0003"	Ratchet	103.50
52-240-010-1	9 - 10"	± 0.0003"	Ratchet	117.30
52-240-011-1	10 - 11"	± 0.00035"	Ratchet	129.70
52-240-012-1	11 - 12"	± 0.00035"	Ratchet	142.20
Sets				
52-215-003-1	0 - 3" with standards and fitted shop hardened case			\$134.60
52-215-004-1	0 - 4" with standards and fitted shop hardened case			192.80
52-215-006-1	0 - 6" with standards and fitted wooden case			327.30
52-215-012-1	0 - 12" with standards and fitted wooden case			992.10
52-215-612-1	6 - 12" with standards and fitted wooden case			654.50

Outside Inch Micrometers

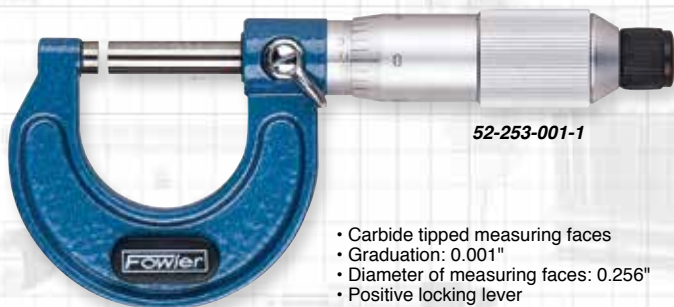

52-253-001-1

- Carbide tipped measuring faces
- Graduation: 0.001"
- Diameter of measuring faces: 0.256"
- Positive locking lever
- Anvil & spindle hardened and precision ground with microlap finish on tips
- Sizes over 1 1/25mm include a calibration standard

Order No.	Range	Accuracy	Thimble		Sale Price
52-253-001-1	0 - 1"	± 0.001"	Friction	Compare to Brown & Sharpe 599-1-44 @ \$103.00	\$32.50
52-253-101-1	0 - 1"	± 0.001"	Ratchet		32.50
52-253-002-1	1 - 2"	± 0.001"	Friction		38.70
52-253-102-1	1 - 2"	± 0.001"	Ratchet		38.70
52-253-003-1	2 - 3"	± 0.001"	Ratchet		45.00
52-253-004-1	3 - 4"	± 0.001"	Ratchet		52.50
52-253-005-1	4 - 5"	± 0.001"	Ratchet		58.60
52-253-006-1	5 - 6"	± 0.001"	Ratchet		64.90

Outside Inch Micrometer Set

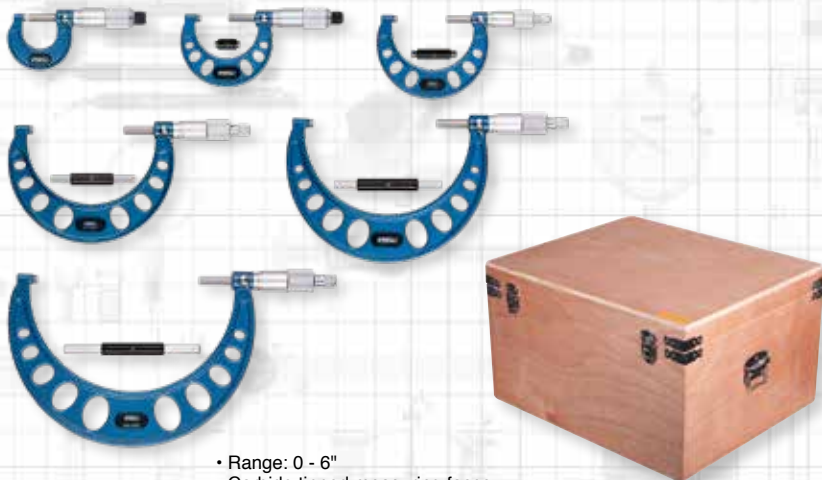

- Range: 0 - 6"
- Carbide tipped measuring faces
- Graduation: 0.001"
- Diameter of measuring faces: 0.256"
- Positive locking lever
- Anvil & spindle hardened and precision ground with microlap finish on tips
- Sizes over 1 1/25mm include a calibration standard

Order No. 52-253-600-1

Sale \$297.⁹⁰

List \$364.10

Prices & Specifications are subject to change without notice.

Large Capacity Inch Micrometers

Fowler's Large Capacity Inch Micrometers are used for larger applications and is available in sizes up to 20". Each micrometer offers superior design and workmanship to ensure high precision and long life — and at economical prices.



- Hammertone blue baked finish
- Microfine graduations on satin chrome finish and carbide tipped measuring faces
- Diameter of measuring faces: 0.295"
- Ratchet stop thimble for exact and repetitive readings
- Flatness: 0.00003"
- Quick, easy zero adjustment on sleeve
- Positive lever locking clamp ensures reliable measurement setting at all times
- Anvil & spindle hardened and precision ground with microlap finish on tips
- Includes a wrench and case
- All sizes include a calibration standard

Order No.	Range	Graduation	Accuracy	List Price	Sale Price
52-240-013-0	12 - 13" w/standards & case	0.001"	0.00044"	\$397.54	\$340.00
52-240-014-0	13 - 14" w/standards & case	0.001"	0.00044"	444.18	370.00
52-240-015-0	14 - 15" w/standards & case	0.001"	0.00044"	457.05	380.00
52-240-016-0	15 - 16" w/standards & case	0.001"	0.00044"	499.73	416.00
52-240-017-0	16 - 17" w/standards & case	0.001"	0.0005"	513.48	430.00
52-240-018-0	17 - 18" w/standards & case	0.001"	0.0005"	557.59	465.00
52-240-019-0	18 - 19" w/standards & case	0.001"	0.0005"	589.60	490.00
52-240-020-0	19 - 20" w/standards & case	0.001"	0.0005"	705.32	580.00

INDI-X® Indicating Micrometers



- Anvil and spindle hardened and precision ground
- Fully insulated frame, satin chrome finish
- Carbide tipped anvil & spindle
- Retracting button conveniently located in relation to operator's hand
- 0 - 1" Range, head graduated in 0.001"
- Flatness: 0.000012"
- Dial graduated in 0.00005"
- Diameter of spindle: 0.256"
- Sizes over 1"/25mm include a calibration standard"
- Includes case

Order No.	Range	Accuracy	List Price	Sale Price
52-245-501-0	0 - 1"	0.00016"	\$396.11	\$340.00
52-245-502-0	1 - 2"	0.00016"	459.36	390.00

Digit Counter Micrometers



52-224-001-0



- Digital counter reads to 0.001"
- Resolution: 0.0001" (using vernier)
- Microfine graduations on satin chrome
- Carbide tipped measuring faces
- Positive locking nut on spindle
- Sizes over 1"/25mm include a calibration standard
- Includes case

52-224-103-0



Order No.	Range		Sale Price
52-224-001-0	0 - 1"	Compare to Mitutoyo 193-211 @ \$144.00	\$105.50
52-224-002-0	1 - 2"		98.50
52-224-003-0	2 - 3"		112.20
52-224-004-0	3 - 4"		123.50
Sets			
52-224-103-0	0 - 3" set		\$296.00
52-224-104-0	0 - 4" set		419.70
52-224-220-0	0 - 75mm set		311.60

Outside Inch Micrometers

with Decimal Equivalents on Frame



52-235-001-1



- Black decimal equivalents on satin chrome finished forged steel frame
- Graduations: 0.0001"
- Ratchet thimble and locking nut
- Sizes over 1"/25mm include a calibration standard

Order No.	Range	Accuracy	Thimble		Sale Price
52-235-001-1	0 - 1"	± 0.0001"	Ratchet	Compare to Starrett T230RL @ \$204.30	\$54.70
52-235-002-2	1 - 2"	± 0.0001"	Ratchet		63.20
52-235-003-2	2 - 3"	± 0.0001"	Ratchet		79.10
Set					
52-235-100-0	0 - 3"				\$190.00

Swiss-Style Micrometers



52-229-201-0



"Awesome set of mics!"
Erik

- 0.0001" reading
- Carbide measuring faces
- Insulated frame
- Ratchet thimble and locking lever
- Microfine graduations
- Sizes over 1"/25mm include a calibration standard
- Includes case



52-229-213-0

Order No.	Range	Accuracy	List Price	Sale Price
52-229-201-0	0 - 1"	± 0.00016"	\$61.05	\$49.00
Sets				
52-229-213-0	0 - 3"	0 - 1", 1 - 2": ± 0.00016" 2 - 3": ± 0.0002"	\$220.11	\$170.00
52-229-214-0	0 - 4"	0 - 1", 1 - 2": ± 0.00016" 2 - 3", 3 - 4": ± 0.0002"	311.63	235.00

Micrometer Stands



52-247-005-0

- Unique locking nut adjusts micrometer stand to any position for perfect use and viewing
- Stand folds for storage



52-247-000-0

- Provides a measuring position and angle for outside micrometers and other instruments

XTRA MAG

52-247-010-0

- Holds standard 0-12" micrometers firmly to metal surfaces
- Use at machine centers, work, assembly and inspection stations, steel tables and shelves
- V-bottom for mounting on cylindrical surfaces
- On/Off magnet switch
- Base is 2.30" L x 1.20" W x 3.50" H



Micrometer not included

Order No.	Description	List Price	Sale Price
52-247-000-0	Adjustable Micrometer Stand	\$67.10	\$48.80
52-247-005-0	Folding Micrometer Stand	44.99	32.80
52-247-010-0	Magnetic Micrometer Stand	70.00	63.00

XTRA-RANGE® Inside Micrometer

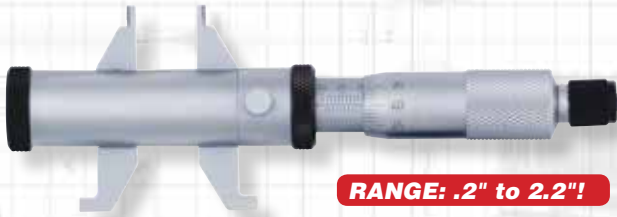

RANGE: .2" to 2.2"!

- Satin chrome finish on barrel and thimble
- Microfine graduations (0.001") on a satin chrome finish permits easy reading
- Accuracy: ± 0.0002 "
- Ratchet stop thimble
- Easy zero adjustment on the sleeve
- Includes a calibration setting ring



Order No. 52-275-005-0

Sale \$158.⁵⁰

List \$217.91

Inside Micrometers

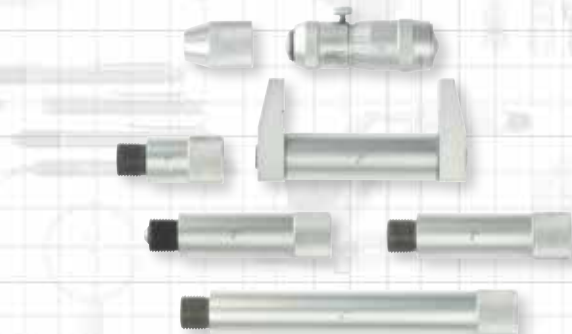

52-243-212-1

- Each set consists of an inside micrometer head and a series of fully hardened and lapped extension rods of different lengths all with carbide measuring faces
- Anvil and spindle are hardened and precision ground with microlap finish on ends
- Microfine graduations on satin chrome
- Positive locking nut on spindle
- Coiled spring pressure contact type rods are each marked with appropriate length
- Quick, easy zero adjustment on the sleeve
- Accuracy: $0.00005" \times (3 + L/2)$
- Graduation: 0.001"
- Includes a wrench, case and reference standard
- It is recommended that the inside micrometer with a rod be calibrated by a micrometer or ring gage

Order No.	Range		Sale Price
52-243-026-1	2 - 6"		\$115.30
52-243-212-1	2 - 12"	Compare to Mitutoyo 139-201 @ \$226.13	142.40
52-243-220-1	2 - 20"		184.60
52-243-240-1	2 - 40"		549.00
52-243-480-1	4 - 80"		1638.00

Prices & Specifications are subject to change without notice.

Fowler - Sylvac Hi_Cal Electronic Height Gages

- Extra low measuring force, from 0.2N
- Measure internal and external diameters, centerlines, heights, widths, depths and MIN/MAX/TIR capability
- Excellent repeatability thanks to the motorized carriage
- High reliability
- Data output USB and RS232
- Battery life: 40 hours rechargeable during operation
- Touch sensitive probe speed for easy operation
- Base with small footprint
- Includes: protective cover, charging set, ruby ball probe Ø3mm, setting gage and calibration certificate

NOW
 available with
ISO Cert.

Contact the Fowler Sales Department
 1-800-788-2353



Accessory Probe Sets



Watch the Demo!



FREE

1mm Ball Probe with

Order No.	Range
54-931-150-0	6"/150mm
54-931-150-C	6"/150mm <i>with ISO/A2LA Certification</i>
54-931-300-0	12"/300mm
54-931-300-C	12"/300mm <i>with ISO/A2LA Certification</i>
54-931-450-0	17.5"/450mm
54-931-450-C	17.5"/450mm <i>with ISO/A2LA Certification</i>
Accessories	
54-930-215-0	Full Probe Accessory Set
54-930-217-0	Basic Probe Accessory Set



54-931-300-0



54-931-450-0

FREE Basic Probe Set
 with 54-931-450-0 Hi_Cal Purchase
\$623.80 Value!

6"/150mm & 12"/300mm Hi_Cal Purchase

Accuracy	List Price	Sale Price
0.00013"/0.0034mm	\$4898.40	\$4408.60
0.00016"/0.0042mm	5629.20	4658.60
0.00020"/0.005mm	6354.00	5416.30
		5718.60
		6068.60
	\$1350.00	\$1215.00
	750.00	675.00

V-Series Special Pricing!

Fowler - Trimos V3, V4 & V5 Electronic Height Gages

The Fowler-Trimos V3, V4 and V5 vertical measuring instruments have been developed for the most difficult workshop environments. Manufactured in their entirety in Switzerland, they guarantee a robust, precise and reliable product in the long run.

- "Black mask" display with user friendly functions
- Electronically adjustable measuring force 0.75/1.5 (N)
- Lithium-ion rechargeable batteries
- All adjustments possible without tools
- Cast iron base for optimal stability
- RS232 and USB interfaces requires 54-192-112-0 cable
- Dual probe holders (V4 and V5 Only)
- Carriage displacement: Manual
(V5 includes selectable manual or motorized carriage displacement)
- Measures heights, diameters, perpendicularity, centerlines, Min/Max/Delta
- Resolution: 0.00005"/0.001mm
- Repeatability (2s): 0.00008"/0.002mm (Ø 0.00016"/0.004mm)



All V Models Include:

- Charging unit
- Measuring insert with ruby ball Ø4mm
- Probe holder elbow Ø 8mm
- Setting gage
- User's manual and test certificate

Free Swiss Knife & Fowler Hat with Any V3, V4 & V5 purchase!



V3	54-192-340-0	54-192-370-0
Measuring Range	16"/407mm	28"/711mm
Range with Probe inverted	20"/508mm	31.9"/812mm
Max. Permissible Errors	0.00028"/0.007mm	0.00032"/0.008mm
Frontal Squareness Deviation	0.0004"/0.010mm	0.0006"/0.015mm
Air Cushion	NO	

V4	54-191-440-0	54-191-470-0
Measuring Range	16"/407mm	28"/711mm
Range with Probe inverted	28.3"/719mm	40.2"/1023mm
Max. Permissible Errors	0.0002"/0.005mm	0.00028"/0.007mm
Frontal Squareness Deviation	0.0004"/0.010mm	0.0006"/0.015mm
Air Cushion	YES	

V5	54-199-540-0	54-199-570-0
Measuring Range	16"/407mm	28"/711mm
Range with Probe inverted	28.3"/719mm	40.2"/1023mm
Max. Permissible Errors (µm)	2.5 + L(mm)/300	
Frontal Squareness Deviation	0.0002"/0.005mm/0.00032"/0.008mm	
Air Cushion	YES	



Order No.	Description	Range	List Price	Sale Price
54-192-340-0	V3 Height Gage	16"/407mm	\$4588.50	\$4129.70
54-192-370-0	V3 Height Gage	28"/711mm	5059.00	4553.10
54-191-440-0	V4 Height Gage	16"/407mm	6044.10	5439.70
54-191-470-0	V4 Height Gage	28"/711mm	7031.20	6328.10
54-199-540-0	V5 Height Gage	16"/407mm	6661.40	5995.30
54-199-570-0	V5 Height Gage	28"/711mm	7894.00	7104.60
Probe Sets				
54-199-105-0	4mm Probe Set, 21 piece		\$1765.30	\$1588.80
54-199-106-0	8mm Probe Set, 16 piece		1317.30	1200.00
54-199-107-0	Economy Probe Set, 7 piece		467.70	450.00
Accessories				
54-199-400-0	12"/300mm Holder - for 8mm probes		\$988.20	\$889.40
54-777-120-0	Vmux software - for connecting multiple units to one PC		465.50	395.00

16"/407mm

\$4,129.⁷⁰

Order No: 54-192-340-0



16"/407mm

\$5,439.⁷⁰

Order No: 54-191-440-0



NOW

available with ISO Cert

Contact the Fowler Sales Department 1-800-788-2353

16"/407mm

\$7,104.⁶⁰

Order No: 54-199-570-0



**EXTREMELY
Easy to Use!**

Twin Beam Electronic Height Gages

with Offset Scriber

- Carriage design with offset scriber holder
- Base is ground and lapped for flatness
- Handwheel provides course and fine movement
- Updated electronic and mechanical design offers better accuracy and movement of carriage
- Carbide tipped scriber
- Functions include preset, in/mm conversion and ABS/INC for direct or comparative measuring



Range	Accuracy
12"	± 0.0016"/0.04mm
24"	± 0.002"/0.05mm

Order No.	Range	List Price	Sale Price
54-174-212-3	12"/300mm	\$549.12	\$399.40
54-174-224-3	24"/600mm	768.68	629.00
Accessory			
54-174-226-0	Contact sensor	\$25.00	\$22.50

Twin Beam Dial Height Gages

- Separate digit counters register both upward & downward travel
- Zero setting can be obtained throughout the gage's range
- Coarse readings in 0.100" graduations: fine readings taken on indicator are 0.001"
- Dual chrome plated beams
- Carbide-tipped scriber.
- Base is hardened, ground & lapped for maximum flatness
- Accuracy: 12" - ± 0.0015"
24" - ± 0.002"



52-174-212-0

Order No.	Range	Sale Price
52-174-212-0	12"	\$269.60
52-174-224-0	24" Compare to Mitutoyo	449.30
192-152 @ \$1,399.00		

Height Gage Centering Cone Set



52-565-100-0

- Locates the hole center as the cone is inserted into a hole
- Use with various height gages
- Measures holes from 1/16" to 1-1/16" ID
- Bar dimensions 5/16" x 3/16"
- Includes 1 holding bar and 2 centering cones

Height Gage CMM Probe Set



52-565-110-0

- Lets you use any M2 threaded CMM probe in your height gage
- Holder comes with 3 ruby ball CMM probes - 2mm ruby ball x 20mm length
- Bar dimensions 1/2" x 1/4"
- Can be adapted for use with various height gages

Order No.	List Price	Sale Price
52-565-100-0	\$103.78	\$80.00
52-565-110-0	105.10	95.00

Electronic Height Gages

An economical height gage that offers high quality, accuracy and durability.



- Large base for easy movement
- Resolution: 0.0005"/.01mm
- Accuracy: ± 0.0025"
- Repeatability: 0.0005"/0.01mm (±2s)
- Large easy to read LCD
- Overall height: 28"
- Presetable display

Order No.	Range	List Price	Sale Price
54-106-020-0	20"/50mm	\$473.55	\$360.00
54-106-040-0	40"/1000mm	2178.44	1200.00

New Design!

- **NEW** base design with painted enamel finish has a more comfortable grip and is finely ground and lapped for smooth movement on surface plates
- **NEW** fine adjust feature allows precise adjustment to required settings
- **NEW** preset feature allows setting pre-determined or reference measurements
- **NEW** 2 indicator holding bars included (3/8" and 8mm)
- Direct inch/metric conversion
- Resolution 0.0005"/0.01mm
- Floating zero
- Large, high contrast LCD display
- Coarse adjustment hand wheel
- Carriage locking lever
- Carbide tipped scriber



54-175-024-0

Order No.	Range	Accuracy	Sale Price
54-175-012-0	12"/300mm	± 0.0016"/0.04mm	\$477.00
54-175-018-0	18"/500mm	± 0.002"/0.05mm	\$56.00
54-175-024-0	24"/600mm	± 0.002"/0.05mm	\$625.80

Compare to Mitutoyo 570-314 @ \$954.85

Vernier Height Gages

- Adjustable main scale. Quickly "reset" zero or for easy reading without special calculations
- Swing-away magnifier plus extra long vernier scales with wide separations in inch and metric
- Fine adjustment mechanism
- Carbide tipped scriber for direct reading over the full range
- Satin-chrome finish for glare free reading. Raised lands prevent friction wear.
- Beam & slide of hardened stainless steel. Base and measuring surfaces all hardened tool steel, carefully ground and microlapped.
- Graduations: 0.001"/0.02mm



52-174-012-0

Order No.	Range	Accuracy	List Price	Sale Price
52-174-012-0	12"/300mm	0.003"/0.08mm	\$350.24	\$175.00
52-174-024-0	24"/600mm	0.004"/0.1mm	801.46	400.00
52-174-040-0	40"/1000mm	0.004"/0.1mm	1821.27	900.00



Fowler-Bowers **BLUETOOTH** XTH3 Holematic Pistol Grip Sets



TABLET!
with Complete Set Purchase!

"Fowler-Bowers makes an awesome product!"
T.T.



BOWERS GROUP



Contact the Fowler Sales Department
1-800-788-2353

54-567-050-BT

- Pistol grip design significantly increases measuring time
- To reduce hand fatigue, the travel of the Holematic trigger is adjustable for minimum over travel
- Self centering 3 point heads above 0.250"
- USB and Bluetooth connectivity
- Resolution: 0.00005"/0.001mm
- Protected to IP67 specifications
- Tungsten carbide measuring faces on all 3-point heads from 0.5" (12.5mm) and up
- Sizes over 0.500" (12.5mm) feature blind bore capability
- Includes UKAS certificates for all pistol grip, heads and rings



Contact the Fowler Technical Department for special measuring applications

Order No.	Range	Includes	List Price	Sale Price
54-567-009-BT	0.080" - 0.250"/2 - 6mm (2-point heads)	5 heads, 1 handle, 3 rings	\$6322.70	\$5374.30
54-567-010-BT	0.250" - 0.375"/6- 10mm	2 heads, 1 handle, 1 ring	2479.20	2107.40
54-567-020-BT	0.375" - 0.750"/10 - 20mm	3 heads, 1 handle, 2 rings	2900.40	2465.40
54-567-050-BT	0.750" - 2" /20 - 50mm	3 heads, 1 handle, 2 rings	3745.00	3183.30
54-567-100-BT	2 - 4"/50 - 100mm	3 heads, 1 handle, 2 rings	4168.40	3543.20
54-567-105-BT	4 - 6"/100 - 150mm	2 heads, 1 handle, 1 ring	3745.00	3183.30
54-567-110-BT	6 - 8"/150 - 200mm	2 heads, 1 handle, 1 ring	4943.30	4201.90
54-567-200-BT	4 - 8"/100 - 200mm	4 heads, 1 handle, 2 rings	7824.30	6650.70
54-567-210-BT	0.750" - 4"/20 - 100mm	6 heads, 1 handle, 4 rings	6094.40	5180.30
54-567-620-BT	0.250" - 0.750"/76 - 20mm	5 heads, 1 handle, 3 rings	3456.70	2938.20
Connectivity Cables/Accessory				
54-115-526-0	Proximity cable with USB connection		\$143.00	\$135.00
54-115-527-0	Proximity cable with serial connection		143.00	135.00
54-115-246-BT	USB bluetooth receiver		50.80	45.80



Fowler-Bowers **BLUETOOTH** XTD3 Electronic Holemike Sets



BOWERS GROUP

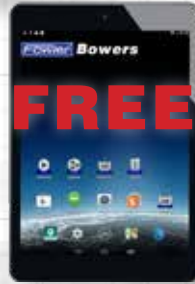

FREE

TABLET!

with Complete Set Purchase!



NOW
available with
ISO Cert.

Contact the Fowler Sales Department
1-800-788-2353



- Features traditional style ratchet stop thimble
- Self centering 3 point heads above 0.250"
- USB and Bluetooth connectivity
- Resolution: 0.00005"/0.001mm
- Protected to IP67 specifications
- Sizes over 1"/25mm offer extended travel
- Includes UKAS certificates for micrometer, heads and settings rings



54-367-110-BT

Contact the Fowler Technical Department for special measuring applications

Order No.	Range	Includes	List Price	Sale Price
54-367-000-BT	0.080" - 0.250"/2 - 6mm (2-point heads)	5 heads, 1 handle, 3 rings	\$5762.20	\$4897.90
54-367-010-BT	0.250" - 0.375"/6 - 10mm	2 heads, 1 handle, 1 ring	2400.90	2040.80
54-367-020-BT	0.375" - 0.750"/10 - 20mm	3 heads, 1 handle, 2 rings	2865.00	2435.30
54-367-050-BT	0.750" - 2" /20 - 50mm	3 heads, 1 handle, 2 rings	3890.80	3307.20
54-367-100-BT	2 - 4"/50 - 100mm	3 heads, 1 handle, 2 rings	4307.70	3661.60
54-367-105-BT	4 - 6"/100 - 150mm	2 heads, 1 handle, 1 ring	3636.70	3091.20
54-367-110-BT	6 - 8" /150 - 200mm	2 heads, 1 handle, 1 ring	4803.90	4083.40
54-367-200-BT	4 - 8" /100 - 200mm	4 heads, 1 handle, 2 rings	7590.70	6452.10
Connectivity Cables/Accessory				
54-115-526-0	Proximity cable with USB connection		\$143.00	\$135.00
54-115-527-0	Proximity cable with serial connection		143.00	135.00
54-115-246-BT	USB bluetooth receiver		50.80	45.80

Prices & Specifications are subject to change without notice.

Fowler-Bowers XT-Series Holemikes



52-255-316-0

The Fowler-Bowers range of mechanical two and three point bore micrometers are now available as XT extended travel holemikes, allowing a wide measurement range without the need to interchange anvils.

- 3-pt contact with tungsten carbide measuring anvils above 0.5"
- Blind bore measuring heads featured above 0.5"
- Ratchet stop for consistent measuring
- Extensions available for deep measuring
- Includes UKAS certificates for all Holemikes and setting rings

Order No.	Range	Grads.	Accuracy	Meas. Depth	Ring Included	List Price	Sale Price
52-255-310-0	0.250" - 0.312"	0.00025"	0.00015"	2.28"	0.312"	\$745.30	\$596.24
52-255-311-0	0.312" - 0.375"	0.00025"	0.00015"	2.28"	0.312"	690.10	552.08
52-255-312-0	0.375" - 0.500"	0.00025"	0.00015"	2.28"	0.5"	690.10	552.08
52-255-313-0	0.500" - 0.625"	0.00025"	0.00015"	2.44"	0.5"	690.10	552.08
52-255-314-0	0.625" - 0.750"	0.00025"	0.00015"	2.44"	0.75"	707.70	566.16
52-255-315-0	0.750" - 1"	0.00025"	0.00015"	2.60"	0.75"	777.20	621.76
52-255-316-0	1" - 1.375"	0.00025"	0.00015"	2.60"	1.375"	1107.40	885.92
52-255-317-0	1.375" - 2"	0.00025"	0.00015"	3.15"	1.375"	1133.80	907.04
52-255-318-0	2" - 2.625"	0.00025"	0.0002"	3.15"	2.625"	1352.50	1082.00
52-255-319-0	2.625" - 3.250"	0.00025"	0.0002"	3.15"	2.625"	1364.60	1091.68
52-255-320-0	3.250" - 4"	0.00025"	0.0002"	3.94"	3.25"	1702.40	1361.92

Fowler-Bowers XT-Series Holemike Sets

Order No.	Range	Includes	List Price	Sale Price
52-255-565-0	0.250" - 0.375"	2 heads, 2 handles, 1 ring	\$1654.90	\$1323.92
52-255-665-0	0.375" - 0.750"	3 heads, 3 handles, 2 rings	1884.50	1507.60
52-255-775-0	0.750" - 2"	3 heads, 3 handles, 2 rings	2961.00	2368.80
52-255-885-0	2" - 4"	3 heads, 3 handles, 2 rings	4014.10	3211.28

Bore Gage Setting Master Kits - Inch & Metric

Fowler's Bore Gage Setting Master Kit is used for accurately setting any bore gage up to 6"/150mm in diameter to an accuracy of 0.0001"/0.003mm

Each Set includes:

Setting Device (53-646-000-1 - Inch Model)

- Base anvil: 3.950" x 1.050"
- Adjustable anvil 2.375" x .375" (two each)
- Internal capacity: 6"/150mm
- Depth capacity: 1"/25mm
- Centralizer capacity width: 2.750"
- Quick-release holder for fast adjustment
- **Can also be used for external setting, depending on application (external mics, snap gages, caliper gages)**

Economy Gage Block Sets

- Inch model:*
- 36 piece
 - Tolerances to .00005"
 - Certificate of Calibration to NIST

Metric model:

- 33 piece
- AS-2 grade
- Certificate of Calibration to NIST



Instructional video available at youtube.com/FowlerVid

53-646-000-1 Bore gage shown not included

Includes:
Bore gage setting master and gage block set.
All in a custom-fitted case!

Order No.	Description	List Price	Sale Price
53-646-000-1	Inch Bore Gage Setting Master Kit	\$350.79	\$315.00
53-646-010-0	Metric Bore Gage Setting Master Kit	365.53	265.90
53-646-005-0	Bore Gage Setting Master Kit - without Gage Blocks	202.29	170.00



Electronic Bore Gage Set

with Carbide Anvils

Industry's two most popular bore gage ranges combined in one easy-to-use electronic set!

Preset size of master for absolute reading and use minimum hold feature to lock on the bore size as the gage is rocked in the part to be measured.

Bore Gage features:

- Range: 1.4 - 6"/35 - 150mm
- Resolution: 0.00005"/0.001mm
- Carbide anvils
- Self-centering

Indicator features:

- Bar graph and numeric digital display
- Preset with recall
- ABS/INC measurement
- Min/Max/TIR



"Excellent quality,
well built."
Lee C.



Order No. 54-646-401-0

Sale \$309.¹⁰

List \$377.74

Dial Bore Gage Sets with Carbide Anvils

- Carbide Anvils
- Easy-to-read
- Economical
- Graduation: 0.0005", 0.0001" or 0.01mm
- Insulated grip
- 9.5" Depth
- Chrome plated handle
- Includes fitted case



52-646-100-0



52-646-400-0



Order No.	Range	Graduation	Sale Price
52-646-100-0	0.7 - 1.5"	0.0005"	\$142.40
52-646-300-0	2 - 6"	0.0005"	117.80
52-646-400-0	1.4 - 6"	0.0005"	179.00
52-646-220-0	35 - 60mm	0.01mm	197.70

Compare to Mitutoyo 511-753 @ \$338.25

Prices & Specifications are subject to change without notice.

Telescoping Gage Sets

Another great tool for easy and accurate measurements. Under spring tension, the plungers of the gage expand from the center to the size of the hole being measured and are then locked in place using the knurled knob. Final hole size is obtained by measuring over the contacts with a micrometer or vernier caliper.

- Contact points are constructed of hardened tool steel, precision ground.
- Double action rigid handle with self-centering feature for quick checking of inside measurements
- Constant spring tension for uniform feel
- 52-470-006-0 covers a measuring range of 5/16" to 6" with measurable depths of 4" to 5"
- 52-470-007-0 covers a measuring range of 5/16" to 6" with measurable depths of 12"

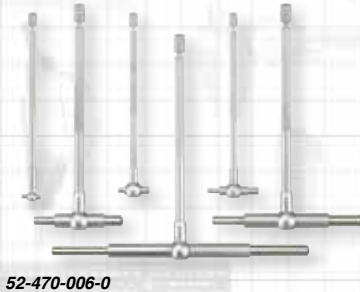

12" Reach!

52-470-007-0



Order No.	Description	List Price	Sale Price
52-470-006-0	6" Telescoping Gage Set	\$122.54	\$99.00
52-470-007-0	12" Telescoping Gage Set	147.51	110.00

Small Hole Gages

- Blind bore style tips for shallow bores, slots and grooves
- Full ball style for general bore measuring
- Hole size is obtained by measuring over the contact points with a caliper or micrometer
- Range: 0.125 - 0.5"
- Hardened gaging surfaces
- Knurled handles
- Includes fitted vinyl case

Available in 2 Styles!

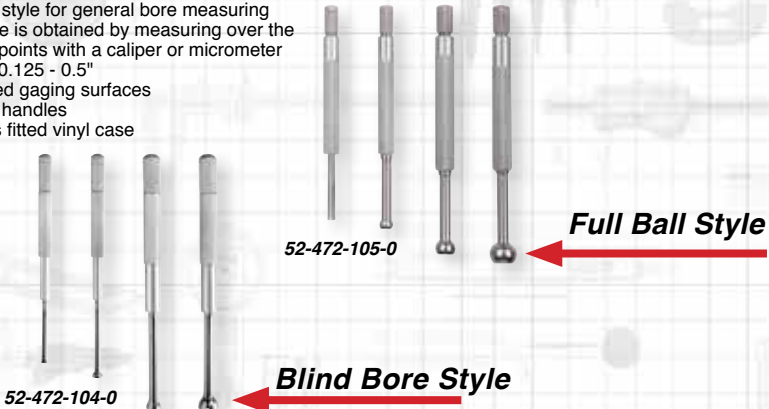

Order No.	Description	List Price	Sale Price
52-472-104-0	Blind Bore Style	\$103.18	\$85.00
52-472-105-0	Full Ball Style	104.06	85.00
Set			
52-472-110-0	Both Blind Bore & Full Ball Small Hole Gage Set	\$164.90	\$130.00

LIFETIME WARRANTY

We are so confident that these Fowler-Sylvac Mark VI electronic indicators are the most accurate, most dependable, best made products you can buy, we are extending the warranty to last a lifetime!

*No Gimmicks
No Hurdles
No Nonsense*

Quality, accuracy, dependability, world-class customer service and now a real Lifetime Warranty!

Mark VI Electronic Indicators

- Robust construction
- Repeatability: 2µm
- Output: Proximity/Power - USB/RS232/digimatic/Wireless
- Menus customizable with free software
- Wide range of functions (MIN/MAX/DELTA, TOL, Factor, Preset, Auto Off, etc)
- Bezel rotates 270°
- Large display with LED tolerance indicators
- Includes lug back



This Button is programmable for common functions

54-530-135-0

NOW
available with
ISO Cert.

Contact the Fowler Sales Department
1-800-788-2353



54-530-535-0

Learn more at
YouTube
FowlerVid



Order No.	Description	Maximum Error	Resolution	List Price	Sale Price
54-530-125-0	0 - 0.500"/12.5mm	0.0004"/0.01mm	0.0005"/0.01mm	\$452.70	\$407.50
54-530-135-0	0 - 0.500"/12.5mm	0.00012"/0.003mm	0.00005"/0.001mm	579.60	\$21.70
54-530-145-0	0 - 1"/25mm	0.0004"/0.01mm	0.0005"/0.01mm	516.70	\$465.10
54-530-155-0	0 - 1"/25mm	0.00016"/0.004mm	0.00005"/0.001mm	618.30	\$56.50
54-530-155-C	0 - 1"/25mm with ISO/A2LA Certification				\$81.50
54-530-175-0	0 - 2"/50mm	0.00019"/0.005mm	0.00005"/0.001mm	\$1170.30	\$1053.30
Bluetooth					
54-530-335-0	0 - 0.500"/12.5mm	0.00012"/0.003mm	0.00005"/0.001mm	\$717.60	\$645.90
54-530-355-0	0 - 1"/25mm	0.00016"/0.004mm	0.00005"/0.001mm	767.40	\$690.70
Accessory					
54-115-246-BT	USB Bluetooth Receiver			\$50.24	\$45.80
Analog Display					
54-530-535-0	0 - 0.500"/12.5mm	0.00012"/0.003mm	0.00005"/0.001mm	\$651.40	\$521.20
54-530-555-0	0 - 1.00"/25mm	0.00016"/0.004mm	0.00005"/0.001mm	712.20	\$569.80

Prices & Specifications are subject to change without notice.

INDI-X^{blue} Electronic Indicators

- 2-1/4" dial face
- Lugback and 3/8" stem mountings
- Resolution 0.0005"/0.01mm
- Tolerance function
- Absolute/incremental reading
- Floating zero



INCH • METRIC • FRACTION™



54-520-255-0

“Easy to use, easy to read, top notch accuracy”
Mr. R.



54-520-260-0



Order No.	Description	Sale Price
54-520-255-0	0.50"/12.5mm Indi-X Blue <i>Compare to Mitutoyo 543-783 @ \$153.79</i>	\$83.40
54-520-260-0	1"/25mm/64ths Indi-X Blue Inch-Metric-Fraction	102.50

INDI-MAX^{blue} Electronic Indicators

- IP54 Coolant & fluid resistant
- Auto Off feature
- 2-1/4" dial face
- 3/8" stem - 4-48 thread
- Resolution 0.00005"/0.001mm
- Accuracy: 0.00016"/0.004mm (to 1")
- Tolerance indicators
- Absolute/incremental reading



54-520-305-0



54-520-310-0



54-520-320-0

Carbide-tipped points!

Order No.	Description	Sale Price
54-520-305-0	0.5"/12.5mm Indi-Max	\$304.90
54-520-310-0	1"/25mm Indi-Max <i>Compare to Mitutoyo 543-476B @ \$395.46</i>	342.00
54-520-320-0	2"/50mm Indi-Max	499.40
Accessory		
52-525-605-0	Lugback for 1" and 2" models	\$15.00
54-520-399-0	SPC cable	137.60

Small Face Electronic Indicator

- Range: 0 - 0.50"/0 - 12.5mm
- Accuracy: $\pm 0.0008"/0.02\text{mm}$
- Resolution: $0.0005"/0.01\text{mm}$
- 1.76" dial face
- Carbide tip
- Contains flat and center lug backs
- Includes NIST certification and fitted case



FREE



Free contact point set
52-525-065-0

Order No. 54-520-275-0

Sale \$75.00

List \$127.16

Depth Base Attachments

- Turn your dial or electronic indicator into a depth gage (may reduce range)
- 4" length
- Fits indicators with 3/8" and 8mm mounting stems
- Ground and lapped base
- Each supplied with 4 extension points, for added application range (4 - 48 thread)
- 52-125-005-0 has 0.430" radius



52-125-004-0

Order No.	Description	List Price	Sale Price
52-125-004-0	Flat depth base attachment	\$45.43	\$37.20
52-125-005-0	Radius style depth base attachment	45.43	37.20

Indicator Chucks



52-526-020-0

- Low carbon steel, black oxide finished
- 0.0140" - 0.040" chucking capacity
- Can be used with small pin gages for special or restricted applications
- Available in both 4 - 48 and M2.5 threads



Indicator shown not included



Order No.	Description	List Price	Sale Price
52-526-020-0	Indicator Chuck with 4 - 48 thread	\$24.20	\$21.80
52-526-021-0	Indicator Chuck with M2.5 thread	24.20	21.80

Premium Dial Indicators

- Tolerance markers
- Solid steel housing
- Carbide contact point



52-520-135-0



52-520-110-1



52-520-110-2

"Great price for a great indicator" V.C.



Includes NIST Certificate of Calibration

Order No.	Range	Graduation	Reading	Balanced Reading	Dial Color	Sale Price
52-520-110-1	1"	0.001"	0 - 100	—	Black	Compare to Mitutoyo 2904S @ \$115.95 \$75.20
52-520-110-2	1"	0.001"	0 - 100	—	White	Compare to Mitutoyo 2904S @ \$115.95 75.20
52-520-105-0	0.50"	0.001"	0 - 100	0 - 50 - 0	White	72.00
52-520-115-0	1"	0.001"	—	0 - 50 - 0	White	89.90
52-520-125-0	0.250"	0.0005"	0 - 50	0 - 25 - 0	White	99.20
52-520-129-0	1"	0.0005"	0 - 50	0 - 25 - 0	White	90.80
52-520-300-0	10mm	0.01mm	0 - 100	0 - 50 - 0	White	85.80
52-520-500-0	25mm	0.01mm	0 - 100	0 - 50 - 0	White	114.40

X-PROOF® IP54 Shockproof Dial Indicators

Protection Includes:

- Rubber bellows on stem
- O-ring seal on safety cap
- O-ring protection for bezel and rotating dial
- Sealed back plate

Specifications:

- Shockproof design
- Continuous reading: 0-100
- Tolerance markers
- AGD Group 2, 2-1/4" dia.
- Lugback and carbide point



52-520-450-0



52-520-455-0

"Very nice piece. Smooth working action. Excellent value!" Gerald K.



Order No.	Range	Graduation	Reading	Contact Point	List Price	Sale Price
52-520-450-0	1"	0.001"	0 - 100	4 - 48 (3/8" stem)	\$86.90	\$65.00
52-520-455-0	1"	0.001"	0 - 100	4 - 48 (3/8" stem)	93.94	70.00



Multimode Electronic Test Indicators

The QuadraTest is the perfect solution to test indicating applications

- 4 measuring modes: Min, Max, TIR and Direct
- 4 measuring resolutions - 0.00005"/0.001mm or 0.0005"/0.01mm
- Water, oil and coolant resistant to IP65
- 1-1/2" diameter dial face rotates a full 360°
- Bar graph and numeric digital display
- Meets or exceeds DIN/ISO Standards (Maximum error on .00005" scale at full range: 0.0004")
- Available with 1/2" or extra-long 1-7/16" contact point



Order No.	Range	Contact Point Length	List Price	Sale Price
54-562-777-0	0.040"/1mm	1/2"	\$358.60	\$330.00
54-562-888-0	0.020"/0.5mm	1-7/16"	388.90	360.00
Accessory				
54-115-528-0	Output Cable USB		\$242.90	\$218.70

Test Indicators

All Fowler Test Indicators include bi-directional constant clockwise rotation, automatic reversal, three dovetail mountings, jeweled movement, two dovetail clamps and a molded case.



52-562-775-0



52-562-780-0



Extra Points

.040" .120"

Order No.	Face Color	Total Range	Dial Reading	Graduation	Dial Diameter	Point Length	List Price	Sale Price
52-562-775-0	white	0.030"	0-15-0	0.0005"	1"	1/2"	\$146.96	\$110.00
52-562-776-0	white	0.030"	0-15-0	0.0005"	1-1/2"	1/2"	153.67	110.00
52-562-780-0	black	0.030"	0-15-0	0.0005"	1-1/2"	1/2"	153.67	110.00



52-563-770-0



52-563-772-0

Extra Points

.040" .120"

Order No.	Face Color	Total Range	Dial Reading	Graduation	Dial Diameter	Point Length	List Price	Sale Price
52-563-770-0	white	0.008"	0-4-0	0.0001"	1"	1/2"	\$146.96	\$110.00
52-563-772-0	black	0.008"	0-4-0	0.0001"	1-1/2"	1/2"	146.96	110.00

Prices & Specifications are subject to change without notice.

XTEST Horizontal Indicators

- Solid brass body
- Super smooth jeweled movement
- Smoother bezel adjustment for easier zero setting
- 0.080" and 0.120" carbide ball contact points (0.040" steel ball)
- 0.060" range with auto reverse and rev. counter
- Easy to read tilted dial
- 5/32" pivotable stem



Includes NIST Certificate of Calibration

Order No.	Graduations	Dial Diameter	Dial Reading	Compare to Brown & Sharpe	Sale Price
52-562-001-0	0.0005"	1-1/2"	0-15-0	Compare to Brown & Sharpe 74.111370 @ \$227.53	\$120.40
52-562-002-0	0.0005"	1"	0-15-0	Compare to Brown & Sharpe 74.111370 @ \$227.53	120.40
52-562-003-0	0.001"	1"	0-15-0		120.40
52-562-008-0	0.01mm	38mm	0-40-0		120.40

XTEST Vertical Indicators

TWICE the range of most indicators!

- Graduations: 0.0005"
- Dial diameter: 1" and dial reading: 0 - 15-0
- Solid brass body and super smooth jeweled movement
- Smoother bezel adjustment for easier zero setting
- 0.080" and 0.120" carbide ball contact points (0.040" steel ball)
- 0.060" range with auto reverse and rev. counter
- 5/32" pivotable stem



Includes NIST Certificate of Calibration

Order No.	Graduations	Dial Diameter	Dial Reading	List Price	Sale Price
52-562-004-0	0.0005"	1-1/2"	0-15-0	\$161.04	\$131.80
52-562-005-0	0.0005"	1"	0-15-0	161.04	131.80
52-562-006-0	0.001"	1"	0-15-0	161.04	131.80

Test Indicator Set with Certificate of Calibration

Test Indicator:

- Auto-reverse
- Jeweled movement
- Range: 0.030"
- Graduation: 0.0005"
- Dial Reading: 0-15-0
- Dial Diameter: 1.125"
- Point length: 0.400"
- Carbide contact points, 0.080" and 0.040"

Set Also Includes:

- Universal clamp
- Height gage attachment
- 3/8" & 1/4" dovetail clamps
- Manufacturer's test certificate
- Meets ANSI Specs for accuracy
- All in a fitted molded case



Order No. **52-562-999-0**

Sale \$131.00

List \$146.60

Granite Dial Gage Stand

- Sturdy and compact with extreme stability
- 6" x 6" x 2" granite base
- Positive lock screw
- Fine adjustment knob for zero setting
- Column height is 8"
- Accepts all lug-back indicators
- This stand is maintenance free
- Flatness: 0.00005"

Indicator not included with stand



Order No. 52-580-030-0

Sale \$110.00

List \$137.50

12" Workshop Transfer X-Stand

The Workshop Transfer Stand is compact in size and lightweight!

Adjusts a variety of ways!



- Overall height 12"
- Revolutionary design
- Large range fine adjustment
- Perfect for applications where the stand is moved and/or needs to be transported from location to location
- Hold test indicators or dial gages with dovetail holders & special adaptors
- Large capacity positioning range
- Can be locked in any position
- Base 3" wide x 3.54" long
- Large handwheel provides fine adjustment
- Stainless steel construction
- Packed in a high quality aluminum case
- Weight 4.8 lbs. (2.2 kg)



Order No. 52-620-717-0

Sale \$110.00

List \$146.96

Prices & Specifications are subject to change without notice.

IP54 Electronic Depth Micrometer



- Range: 0 - 6"/150 mm
- Resolution: 0.00005"/0.001mm
- Hardened tool steel, precision ground and microlapped 4" base
- Rod diameter: 0.176"
- Protected to IP54 standards
- Automatic switch off
- Large LCD display
- Includes fitted case



Order No. 54-225-456-0

Sale \$210.⁰⁰
List \$257.40

X-DEPTH 22 0 - 22" Dial Depth Gages

Twice the range of competitive products!

- 0 - 1" travel indicator
- 0.001" Graduations
- Rods connect together for full 22" capacity
- Satin chrome finish
- Base size: 4"
- Includes 2 extra points for small hole applications; one 0.078" dia. x 1" long and one needle point x 1" long



52-125-006-1



52-125-008-0



Order No.	Range	Graduation	Accuracy	List Price	Sale Price
52-125-006-1	0 - 22"	0.001"	± 0.001"	\$223.52	\$182.90
52-125-008-0	0 - 22"/558mm	0.001"/0.01mm	± 0.001"/0.03mm	243.65	150.00

X-PROOF® 0 - 22" Dial Depth Gage with IP54 protection!



Order No. 52-125-007-0

- 0-1" AGD Group 2 IP54 Indicator
- Sealed bezel, top cap and dial with bellows on stem
- Sealed back plate
- .001" graduations
- 4" base ground and lapped for flatness
- Rods connect for 22" capacity
- Includes 2 extra points (spline & needle)
- Tolerance markers



Sale \$150.⁰⁰
List \$242.88

Magnetic Bases

- 9.5" Height and 85 lb. pull
- Base dimensions are 2" x 2-11/32" x 1-13/16" (50mm x 58.7mm x 46mm)
- Accepts all AGD dial indicators
- V-bottom base allows mounting on cylindrical surfaces
- Mounts test indicators with 1/4" post mount



Order No.	Description	List Price	Sale Price
52-585-005-0	Magnetic base	\$58.74	\$43.00
52-585-010-0	Magnetic base w/fine adjustment	69.08	50.00

Hydraulic Arm Magnetic Base

- All purpose magnetic base with 180 lbs. of pulling power
- Fine adjustment
- Base can be mounted vertically as well as horizontally,
- V-bottom base allows mounting on cylindrical surfaces

Adjusts to Virtually Any Position!



Order No. 52-585-095-0

Sale \$174.⁰⁰

List \$232.87

Flex Arm Mag Base

- Corrosion resistant chrome plated flex arm
- 85 lb pull magnetic base
- Base can be mounted vertically as well as horizontally
- V-bottom base allows mounting on cylindrical surfaces
- Adjusts to virtually any position



Order No. 52-585-045-0

Sale \$83.⁵⁰

List \$114.73

Fowler

TOOL-A-THON[®]

2020



Find us on social media!

American Made Tools!



NEW!

52-330-012-1

America Rules

- Made in the USA
- Available in 4R, 5R and IN/MM graduations

GRADUATIONS

- 4R:** 8ths, 16ths, 32nds, 64ths
- 5R:** 32nds, 64ths, 10ths, 100ths
- IN/MM:** 32nds, 64ths, 0.5mm, 1mm

EZ-Read High Contrast Rules

- Hardened stainless steel
- White, microfine graduations against a black background provide a non-glare finish which is extremely easy-to-read

Satin Chrome Rules

- Tempered steel
- Non-glare satin chrome finish
- Sharp easy-to-read graduations

Golden Rules

- Titanium finish = RC80 for superior wear resistance on flat surfaces
- 30% harder finish than standard chrome rules

RIGID STEEL RULES

Order No.	Finish	Size	Reading	Sale Price
52-307-006-1	Black	6"	5R	22.80
52-307-012-1	Black	12"	5R	36.40
52-330-006-1	Satin Chrome	6"	4R	22.80
52-330-012-1	Satin Chrome	12"	4R	Compare to Starrett C304SRE-12 @ \$57.99 36.40
52-380-005-1	Satin Chrome	6"	IN/MM	23.70

FLEXIBLE STEEL RULES

Order No.	Finish	Size	Reading	Sale Price
52-297-006-1	Black	6"	4R	22.50
52-297-012-1	Black	12"	4R	36.40
52-300-006-2	Satin Chrome	6"	5R	Compare to Starrett C305R-6 @ \$25.89 22.80
52-300-012-1	Satin Chrome	12"	5R	36.40
52-309-006-1	Golden	6"	5R	50.10
52-309-012-1	Golden	12"	5R	100.00
52-380-006-1	Satin Chrome	6"	IN/MM	22.80

Screw Pitch Gages



52-485-051-0

- Narrow designed blades permit use for internal and external screw threads
- Locking device at each end to secure all blades for storage or position
- Correct pitch is determined by matching blade teeth with threads
- Precisely ground and finished
- Blades marked with thread size



Order No.	Description	List Price	Sale Price
52-485-051-0	Inch Screw Pitch Gage with 51 blades: 4 to 84 pitch standard V thread	\$55.00	\$44.00
52-485-018-0	Metric Screw Pitch Gage with 18 blades: 0.50 to 7.0mm center gage with coarse and fine notch included	22.00	17.60
52-485-027-0	In/mm Screw Pitch Gage with 28 blades Inch: 4 to 56 pitch, Metric: 0.50 to 6.00mm	22.00	17.60

American Made Tools!

Electronic Edge Finders

- Six equally spaced light ports provide visibility at any angle
- Edge finder lights instantly when stylus touches work edge
- Repeatability: 0.0002"
- Works on any conductive metal



54-575-600-0



54-575-625-0



Order No.	Stylus	Shank	Audible	Battery	List Price	Sale Price
54-575-600-0	0.200"	1/2"	NO	12 volt	\$42.00	\$37.80
54-575-625-0	0.200"	1/2"	NO	12 volt	145.00	130.50

Rectangular Head Protractors

- Measures angles from 0-180 degrees
- Used to transfer angles and to set bevels
- 6" arm with knurled thumb lock nut
- Made of chrome steel with satin finish
- Measures 3-5/16" x 2". Rectangular head provides four working edges. Blade secured firmly at any angle by a lock joint and knurled nut.

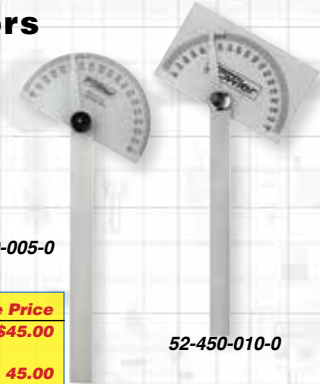

52-450-005-0

52-450-010-0

Order No.	Description	Sale Price
52-450-005-0	Protractor w/semi-circular head	Compare to Starrett \$45.00 C19 @ \$97.20
52-450-010-0	Protractor w/rectangular head	Compare to Starrett 45.00 C183 @ \$87.31

TAP-X

Cam-Locking Tap Wrench

3-times the Range of Most Tap Wrenches!

1/8" to 1/2" (3 to 12mm)

QUICK RELEASE CAM!

FAST & TIGHT!

CHANGE TAPS FAST!

- Fits wide range of tap sizes: 1/8" to 1/2" (M3 to M12)
- Patented Revolutionary Cam-Lock System
- Quick-action clamping for easy replacement
- Taps will never release during use
- Heavy-duty design for reliability and long life
- Handles extreme torque
- Can be used as a hand drill for sizes: 1/16" to 5/16"



Order No. 52-492-350-0

Sale \$35.00

List \$50.81

Prices & Specifications are subject to change without notice.

Fowler Digi-Pro Electronic Protractors

The Digi-Pro electronic protractor includes embedded magnets for unique measurement areas. On/Off, Zero, Hold and Reverse feature to invert the display for easier reading in certain situations.

- Embedded 25 lb. pull magnets
- Full, 360° measuring range
- Accuracy: $\pm 0.2^\circ$
- Repeatability: $\pm 0.05^\circ$
- Resolution: 0.05°
- Invertible display feature
- Voltage: Standard 3V lithium battery

Use the Digi-Pro to make fast and accurate angular measurements!



54-440-775-1

54-440-740-1

Order No.	Description	List Price	Sale Price
54-440-740-1	4" Digi-Pro Electronic Protractor	\$102.30	\$83.00
54-440-775-1	12" Digi-Pro Electronic Protractor	122.65	99.00

mini-MAG Protractor™

The mini-MAG Protractor provides instant 360° digital inclination display of any angle with the additional unique feature of embedded magnets on both sides and the bottom which make it ideal for a variety of measurements.

- Embedded magnets with 3.5lb. pull
- Uses standard 9V battery (250 hrs.)
- Measuring range: 360° (4 x 90°)
- Display automatically inverts
- Resolution: 0.05°
- Accuracy: $\pm 0.2^\circ$
- Repeatability: 0.05°
- Dimensions: 2.375" x 1.375" x 2.375"
- Hold feature



Display inverts for easy reading!



Order No. 54-422-450-1

Sale \$95.00 List \$117.48

mini-MAG PLUS

The Mini-Mag PLUS Protractor features a USB rechargeable battery, a backlit display, Tilt% function and IP54 protection against water, oil, and fluids.

- 6 month battery life
- Auto off after 5 minutes
- Embedded magnets
- Measuring range: 360° (4 x 90)
- Display automatically inverts
- Resolution: 0.05°
- Accuracy: $\pm 0.2^\circ$
- Repeatability: 0.05°
- Hold feature
- Zero function
- Smaller size: 2.12" x 2.12" x .9"



Order No. 54-422-500-0

Sale \$106.00 List \$129.91

SHOP-BLOX®

36 Piece Rectangular Gage Block Set



- Manufactured to meet N.I.S.T. Federal Specification ASME B89. 1.9 - 2002 tolerances on length for inch gage blocks
- Certificate of Calibration traceable to N.I.S.T.
- Tolerances to $\pm 0.00005''$
- In high-quality fitted wood case

Order No. 53-672-036-0

Sale \$255.⁰⁰

List \$357.36

1-2-3 & 2-3-4 Blocks

- 23 holes for easy clamping
- 52-439-001-0 features one hole only
- Sold in pairs
- Hardened 56 - 60 HRC
- Useful in layout and grinding work



52-439-001-0



52-439-234-0

Order No.	Description	Accuracy	List Price	Sale Price
52-439-001-0	1-2-3 Blocks w/ 1 hole	$\pm 0.0002''/1''$	\$161.81	\$115.00
52-439-031-0	1-2-3 Blocks w/ 31 holes	$\pm 0.0001''/1''$	105.82	77.00
52-439-234-0	2-3-4 Blocks	$\pm 0.0001''/1''$	110.00	92.00

X-BLOX® V-Block Set

2 each @:

- Dimensions: 1-1/2" L x 1-1/4" W x 1-1/4" H
- Work capacity: Approximately 1"

2 each @:

- Dimensions: 2" L x 1-1/2" W x 1-1/2" H
- Work capacity: 1-1/2"

All feature:

- Surfaces are square and parallel within 0.0005"
- V-grooves are square and parallel with all surfaces within 0.0005"
- Corresponding dimensions for each pair are alike within 0.0005"



"You will not go wrong buying this product"

J.B

Order No. 52-475-500-0

Sale \$124.¹⁰

List \$137.80

Prices & Specifications are subject to change without notice.

Fowler

TOOL-A-THON®

2020

Find us on social media!

f E in You

COAX-2D

2 Dimensional Coaxial Indicator Set - Inch

Use the 2D Coaxial Set for accurate component centering and positioning in most machining applications. The dial remains stationary during the rotation of the machine spindle.

- Indicator assembly with 1.6" (42.5mm) diameter dial
- Graduations and revolution counter 0.0005" (.01mm)
- 3 Internal and 3 External feelers
- Center point feeler
- Restraining arm



Specifications:

- Length: 6-7/8" (175mm)
- Shank: 3/8" dia. x 7/8" (10mm x 20mm) long
- Feeler ball: 1/8" (3mm) dia.
- Dial readings: 0-50
- Measuring range: 0.250" (6mm) axis offset
- Speed – recommended not to exceed approx. 800 RPM
- Repeatability to within 0.0002" (0.005mm) of true center
- Capacity depends on feelers installed, but overall range is 5/32-12" (4-300mm) internal diameter; 0-12" (0-300mm) external diameter

Order No. **52-710-025-0**

Compare to Blake COA-850 @ \$399.95

Sale \$230.⁶⁰



Combination Square

- Blades are chrome plated, fully hardened and tempered
- Includes square, protractor and center head with 12" blade
- Square head has level and scriber point
- Double indexed protractor is graduated 180° in both directions
- Graduated in 8ths, 16ths, 32nds and 64ths



Order No. **52-370-012-0**

Compare to Starrett 434-12-4R @ \$297.99

Sale \$172.⁰⁰

12" Cylindrical Square

- Used for checking squares, height gages and other instruments
- Hardened and the ends are lapped to 90° angular accuracy
- 6" cylindrical squares: ± 0.0001"
- 12" cylindrical square: ± 0.00015"
- Includes handles and wood case



Order No. **52-750-012-0**

Sale \$261.⁰⁰

List \$318.89

Carbide Super Scriber



- Lightweight • Retractable carbide tip • Knurled grip • Machined aluminum body • Pocket clip

Order No.	Description	Overall Length	List Price	Sale Price
52-500-050-0	Carbide Super Scriber	6.5"	\$36.10	\$32.50
52-500-055-0	Carbide Refill		11.10	10.00

Metal Etching Pen

A "must" for any tool room and machine shop for general marking purposes, Fowler's metal etching pen is used on copper, copper alloy, stainless steel, hardened steel tools and castings, etc. Use it to initial personal tools. Its low-cost, disposable design offers limitless applications. Overall length is 6-1/4"



Order No. 52-730-005-0

Sale \$16.00

List \$22.10

Super Heavy Duty Automatic Center Punch



- Handle constructed in steel. Four knurled bands provide a sturdy grip
- Moveable components are made from tool steel and hardened
- The point is easily removed for sharpening
- The pressure of marking is controlled by rotating the knurled cap. Screw the cap down for heavy indentations and screw the cap upward for lighter markings.

Order No. 52-500-290-0

Sale \$21.00

List \$22.40

XTRA-PUNCH Heavy Duty Transfer Punch Set

- 1/2" - 1" range in 1/64"
- 36 piece set, 3 master punches and 33 individually sized sleeves
- Simply select the laser etched sleeve for the size required, place it on one of the master punches for that range and it is ready to use
- Punch tips are hardened 48-55 HRC
- Master punches are 4-7/8" in length and sleeves are 1" in length
- 1/4" the weight of a conventional transfer punch set



Order No. 52-482-040-0

Sale \$94.00

List \$104.72

Prices & Specifications are subject to change without notice.

Fowler

TOOL-A-THON®

2020



Find us on social media!

1/32" Premium Parallel Set

- Made from high-grade alloy steel, hardened and ground from 1/32" stock with 2 holes in each parallel.
- 10 pairs, 6" length, 1/32" width.
- 1/2", 5/8", 3/4", 7/8", 1", 1-1/8", 1-1/4", 1-3/8", 1-1/2" & 1-5/8"
- Height specifications relate to consistency within each pair. Absolute heights are nominal.
- Parallelism: $\pm 0.0001"$
- Paired in height: $\pm 0.0001"$
- Hardness: 50 HRC



Order No. **52-437-031-0**

Sale \$216.00

List \$254.10

1/8" Parallel Set

- Made from high-grade alloy steel, hardened and ground from 1/8" stock with 2 holes in each parallel
- 10 pairs, 6" length, 1/8" width
- 1/2", 5/8", 3/4", 7/8", 1", 1-1/8", 1-1/4", 1-3/8", 1-1/2" & 1-5/8"
- Height specifications relate to consistency within each pair. Absolute heights are nominal.
- Parallelism: $\pm 0.0002"$
- Hardness 58 - -63 HRC
- Paired in height: $\pm 0.001"$



Order No. **52-437-000-0**

Sale \$196.40

List \$270.05

1/2" Parallel Set

- Set of four pairs of parallels are hardened and ground. A must for every shop.
- Sizes: 1", 1-1/4", 1-1/2" and 1-3/4" in height x 6" long with 5/16" holes
- 1-1/2" and 1-3/4" parallels are 1/2" thick
- 1" and 1-1/4" parallels are 3/16" thick
- Width & height variations: maximum .0004"
- Includes fitted case



Order No. **52-437-001-0**

Sale \$185.00

List \$255.09

X-PRO™

- Small, compact size
- 2 selectable parameters: Ra and Rz
- Large LCD display
- Meets ISO and DIN standards
- N.I.S.T. traceable specimen included
- Uses 9 volt battery (approx. 3000 measurements)
- Includes fitted case



54-410-500-0



The X-Pro Portable Roughness Tester II can be used for many applications by selecting from a variety of accessories, including:

- Stand with swivel
- A variety of probes

RS232 is available on certain models (contact the Fowler technical department for more information)



(X-Pro shown with optional stand with swivel)

X-Pro Portable Roughness Tester II

Order No.	Description	Sale Price
54-410-500-0	Portable Surface Roughness Tester 0.0004" probe (NIST specifications) <i>Compare to MAHR EMD-1500-311 @ \$2395.00</i>	\$1666.70
54-410-600-0	Portable Surface Roughness Tester 0.0002" probe (DIN specifications) <i>Compare to MAHR EMD-1500-311 @ \$2395.00</i>	1666.70

X-Pro Portable Roughness Tester II Stand with Swivel

Order No.	Description	Sale Price
54-400-896-0	Stand with Swivel Attachment	\$441.00

X-Pro Portable Roughness Tester II Probes and Accessories

Order No.	Description	Resolution	Sale Price
54-400-319-0	General Purpose Probe	0.0004"	\$720.00
54-400-326-0	General Purpose Probe	0.0002"	720.00
54-420-321-0	Small Bore Probe	0.0004"	778.50
54-420-327-0	Small Bore Probe	0.0002"	778.50
54-420-301-0	Traverse Chisel Probe	0.0004"	778.50
54-420-302-0	Parallel Chisel Probe	0.0004"	778.50
54-420-328-0	Groove Bottom Probe	0.0004"	778.50
54-420-120-0	AC Adapter Kit		61.40

Prices & Specifications are subject to change without notice.

Tool Presetter

Quick checking of heights and diameters (radius) of all kinds of tools such as ISO, BT, HSK, VDIA etc. is guaranteed by a fixed precise steel measuring column with displacement devices in coordinates (X/Z) and constant measuring force.

Tool Holding Spindle

Tool presetter is supplied with high precision imported ball cage bearing (Grade 0)
High precision spindle has:

- ISO 50 taper
- Less than 2 μm concentricity error



Display

- MIN/MAX functions for TIR readings
- 2 reference indications for measurement comparison
- Function for PRESET value and TOLERANCE value inputs
- Tolerance mode indication for upper and lower values
- Radius or diameter indication on X-axis display
- Measuring unit (mm/inch) indication
- Low battery warning indication
- Display hold to retain readings
- Output - OPTO RS232 for each axis
- Floating zero function anywhere within axis range
- Carbide measuring insert for durability
- Accepts measuring probes with 8mm shank for unique applications

Additional Features

- Counter balanced measuring carriage
- Constant measuring force of horizontal measuring arm ensures high accuracy
- **High precision Sylvac measuring system**



Applications



Height Measurement



Diameter/Radius Measurements



Checking of a Runout

Order No.	Description	List Price	Sale Price
54-188-300-0	Tool Presetter	\$10049.50	\$9350.00
54-121-000-0	ISO 50/45 Tool Pot Adaptor	1131.20	
54-121-005-0	ISO 50/40 Tool Pot Adaptor	772.40	
54-121-010-0	ISO 50/35 Tool Pot Adaptor	1131.20	
54-121-015-0	ISO 50/30 Tool Pot Adaptor	878.70	
54-188-333-0	ISO 50 Setting Gage	568.00	
54-188-335-0	ISO 40 Setting Gage	1136.10	

Z-CHECK 65 PLUS+

Z-Axis Tool Setter

- Supplied with zero reference setting block
- Easy to read super large display
- Back light turns on when zero reference is achieved
- IP65 protected for fluid and coolant resistance
- 4 magnets embedded into base
- 2" default setting height
- Steel contact surface with 0.0002" flatness
- Range: 0.12"/3mm
- Resolution: 0.00005"/0.001mm
- Repeatability: 0.00015"/0.004mm
- Accuracy: 0.0001"/0.003mm
- Uses 1 3V CR2032 battery
- Includes a rugged, aluminum fitted case



Display lights when ZERO reference is reached



Protected to:
IP65
COOLANT & FLUID
RESISTANT

NEW!

Order No. 54-188-200-0

Sale \$105.00

List \$124.63

HIGH Accuracy Z-Axis Detectors

For use in CNC Machines and other applications where high accuracy is required!

NEW!



54-188-140-0



Micro Drill Application



- High accuracy and repeatability, $\pm 0.000039"/0.001$ mm
- IP67 protection
- Carbide touch surface (0.196"/5mm)
- High precision bearing guide system for long life
- Interchangeable magnetic base
- High visibility LED indicator
- Movement stroke 0.078"/2mm
- Trigger force: 54-188-140-0, 1.0N (3.6 oz./100g)
54-188-150-0, 0.5N (1.8 oz./50g)
- Operation temperature +5°C to 50°C (40°F to 120°F)
- Uses 2, 1.5V batteries (SR44 or LR44)
- Battery life approximately 250 hours (on time)

54-188-140-0

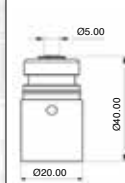

54-188-150-0

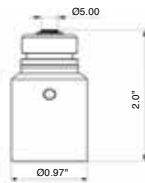

Order No.	Model	Dimensions	List Price	Sale Price
54-188-140-0	Metric	Height: 1.57"/40mm, Dia. 0.78"/20mm	\$267.70	\$240.00
54-188-150-0	Inch	Height: 2"/50.8mm, Dia. 0.97"/24.638mm	267.70	240.00

Prices & Specifications are subject to change without notice.

55

Fowler

TOOL-A-THON®

2020

Find us on social media!



Headquarters

66 Rowe Street • Newton • Massachusetts 02466
(800) 788-2353 • (617) 332-4137 fax
sales@fowlerprecision.com

Distribution Center & Showroom

28010 Industry Drive
Valencia, California 91355
(415) 633-5354