

MeasurLink[®] ENABLED
Data Management Software by Mitutoyo



SPRING PROMO 2018

PRECISION TOOLS & INSTRUMENTS

Effective April 2 through June 29, 2018

SPRING PROMO 2018

10% Off Linear Height LH-600
PLUS Complimentary Accredited Calibration and Shipping*



Linear Height LH-600E

10% Off - Plus Complimentary Accredited Calibration (A2LA 0750.01) and Shipping*

Package



Dear Valued Customers,

I want to take a moment to express my sincere appreciation for your continued support and commitment to Mitutoyo products and services.

Inside the pages of the 2018 spring promotion, you will find a lot of great deals on a variety of Mitutoyo tools and instruments including calipers, micrometers, indicators, height gages and profile projectors. Our featured products can be found on pages 2 - 5. Prices are effective April 2 - June 29, 2018.

You can find all of the latest promotions, products and events on our website, www.mitutoyo.com.

Thank you for trusting us with your metrology needs.

Sincerely,

Matthew B. Dye

Matt Dye
President, Mitutoyo America Corporation

Mitutoyo products are sold only through authorized distributors. To find an authorized Mitutoyo distributor near you, visit: www.mitutoyo.com/distributor-locator/



Linear Height LH-600E

The Mitutoyo Linear Height LH-600E offers advanced performance for reliable and easy 2D measurement.

Measuring Range (stroke) 0-38"(24") / 0-972mm(600mm)

- > Excellent accuracy of $(1.1+0.6L/600)\mu\text{m}$ with $0.1\mu\text{m}/0.5\mu\text{m}$ resolution/repeatability.
- > Perpendicularity of $5\mu\text{m}$ and straightness of $4\mu\text{m}$ are guaranteed.
- > Pneumatic full/semi-floating system.
- > One-key operation for running a semi-automatic measurement.
- > Data entry from a Digimatic tool.



VIDEO DEMO



5.7" color LCD

MeasurLink[®] ENABLED
Data Management Software by Mitutoyo



*Complimentary accredited calibration applies to orders placed April 2 through June 29, 2018. Mitutoyo America Corporation reserves the right to change or discontinue this offer at any time. This offer is void wherever prohibited or restricted by law. No cash value. Complimentary accredited calibration will be conducted prior to unit shipping and cannot be applied toward previously placed orders. Refer to our terms and conditions for further details.

*Complimentary ground shipping for the 48 contiguous United States. Offer applies to orders placed April 1 through June 29, 2018. Mitutoyo America Corporation reserves the right to change or discontinue this offer at any time. This offer is void wherever prohibited or restricted by law. No cash value. For Alaska and Hawaii special rates apply. Contact us for details. Complimentary shipping cannot be applied toward previously placed orders. Orders may only be shipped to a single address. If customer returns product, they are responsible for the shipping cost. Refer to our terms and conditions for further details.

Promo Price
\$7,632

518-351A-21
standard

PROMO027



Promo Price
\$8,091

518-352A-21
with power grip

PROMO028

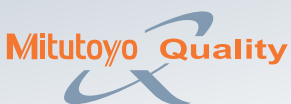

Purchase the world's first 5μinch / 0.1μm resolution micrometer and receive a USB input tool and cable (\$280 value)

Using precision digital measuring tools together with a USB input tool improves both measurement results and data reliability. The latest version of digimatic output, d2, allows output to a resolution of 1 millionths of an inch. The high-accuracy MDH with 5 millionths resolution can be output in its entirety in both inch and metric. Resulting data can be input directly to Excel, MeasurLink® or other SPC programs.

To receive this special offer, use promo code: **PROMO026**.

Part #	Description	List Price
PROMO026	Package: MDH Mic, SPC Cable, USB Input Tool	\$1,630.00
293-130-10	MDH Micrometer with high accuracy, high resolution output	\$1,630.00
05CZA662	SPC CONNECTING CABLE (1M)	\$83.80
264-016-10	USB INPUT TOOL	\$197.00



High accuracy, high resolution MDH Micrometer with new d2 output

- > Enabling .000005"/0.0001mm resolution measurement, this micrometer is ideal for those who need to make highly accurate measurements with a handheld tool.
- > The ABS (absolute) rotary sensor eliminates the need to perform origin setting each time the power is turned on, allowing you to start measuring right away. With no possibility of overspeed errors, the high-accuracy digimatic micrometer delivers a higher level of reliability.
- > Certificate of inspection provided.



Order No.	Range	Resolution	Accuracy
293-130-10	0 - 1" / 0 - 25.4mm	.000005"/.00002" 0.0001mm/0.0005mm (switchable)	±.00002"

Model	Display	Output	Format
Standard Micrometer	.01235	.01235	Digimatic
MDH Micrometer w/d2	.012345	.012345	Digimatic d2



Function lock

MeasurLink ENABLED
Data Management Software by Mitutoyo

Dial Test Indicators



Order No.	Range	Graduations	Set Type	Face Color	List	Promo
Standard						
513-401-10E	0.14mm	0.001mm	Basic	Yellow	\$221.00	\$198.90
513-402-10E	.03"	.0005"	Basic	White	\$130.00	\$117.00
513-402-10T	.03"	.0005"	Full	White	\$154.00	\$138.60
513-403-10E	.008"	.0001"	Basic	White	\$169.00	\$152.10
513-403-10T	.008"	.0001"	Full	White	\$198.00	\$178.20
513-404-10A	0.8mm	0.01mm	Plus	Yellow	\$145.00	\$130.50
513-404-10E	0.8mm	0.01mm	Basic	Yellow	\$132.00	\$118.80
513-406-10E	.03"/0.7mm	.0005"/0.01mm	Basic	White/Yellow	\$152.00	\$136.80
513-406-10T	.03"/0.7mm	.0005"/0.01mm	Full	White/Yellow	\$152.00	\$136.80
513-409-10E	0.2mm/.0076"	0.002mm/.0001"	Basic	Yellow/White	\$196.00	\$176.40
513-409-10T	0.2mm/.0076"	0.002mm/.0001"	Full	Yellow/White	\$199.00	\$179.10
513-412-10E	.03"	.0005"	Basic	White	\$186.00	\$167.40
513-412-10T	.03"	.0005"	Full	White	\$215.00	\$193.50
Ruby Tip						
513-479-10E	.03"	.0005"	Basic	White	\$153.00	\$137.70
Standard (20° tilted face)						
513-442-10A	.06"	.0005"	Basic	White	\$176.00	\$158.40
513-442-10T	.06"	.0005"	Full	White	\$199.00	\$179.10
513-446-16A	.06"	.0005"	Basic	Black	\$235.00	\$211.50
513-446-16T	.06"	.0005"	Full	Black	\$265.00	\$238.50
Vertical: dial is on the top of the frame						
513-452-10E	.03"	.0005"	Basic	White	\$169.00	\$152.10
513-452-10T	.03"	.0005"	Full	White	\$186.00	\$167.40
Horizontal: dial is on the side of the frame						
513-485-10E	0.2mm	0.002mm	Basic	Yellow	\$215.00	\$193.50

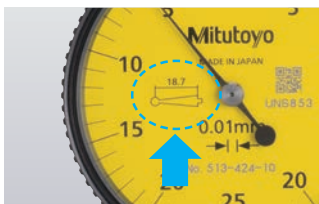

Contact point length is printed on dial face to avoid accuracy issues



Scratch and smudge-resistant, anti-glare crystal for easy-to-read dial

Set Configuration

Inch

Full set

- Contact point, .039" DIA. carbide
- Contact point, .118" DIA. carbide
- Stem, .157" DIA. (190318)
- Swivel clamp 900322, for .157" DIA., 3/8" DIA. dovetail
- Inch holding bar (L: 4") (900306)

Basic set

- Contact point, .079" DIA. (Carbide)
- Indicator
- Knurled clamp ring
- Stem, .157" DIA. (190318)
- Stem, 3/8" DIA.

T set

E, A set

Metric

Full set

- Swivel clamp (900321, for ø4mm, ø8mm, dovetail)
- Metric holding bar (L: 100mm) (900209)

Plus set

- Contact point, ø1mm carbide
- Contact point, ø3mm carbide
- Stem, ø4mm (190318)

Basic set

- Contact point, ø2mm (Carbide)
- Indicator
- Knurled clamp ring
- Stem, ø8mm (Set No. 902804)

T set

A set

C set (ø 6 Stem)

E set

H set (ø 6 Stem)

Calculation-Type Digimatic Indicator ID-C

- > The Absolute Digimatic indicator performs internal calculations using the formula $Ax+B+Cx-1$ (assuming spindle displacement as x), while the specified coefficients A, B and C can be set with respect to the purpose of measurement or dimensions of the fixtures. This unique feature allows for reading measurements directly, without fumbling for conversions.
- > Calculation-Type Digimatic Indicator features both a key lock and parameter lock.
- > Fast measurement frequency up to 50 per second.
- > An analog bar provides easy-to-read values when scanning for Max, Min and TIR Values.

- > Improved parameter setting software makes it even easier to set all of the available parameters and determine and upload the proper coefficients for calculation. (optional) **21EZA313**



MeasurLink ENABLED
Data Management Software by Mitutoyo



www.mitutoyo.com/dccal
VIDEO DEMO



Stem dia. 3/8" #4-48 UNF Thread

Order No.	Resolution	Range	Accuracy	Measuring Force	List	Promo
543-342B	.00005/.0001/.0005"	.5"/12.7mm	±.00010"/0.003mm	1.5N or less	\$445.00	\$400.50
543-592B	(0.001/0.01mm)	1"/25.4mm	±.00010"/0.003mm	1.8N or less	\$596.00	\$536.40
543-597B	Selectable	2"/50.8mm	±.00025"/0.006mm	2.3N or less	\$748.00	\$673.20

SPC cable – 1m: **905338** 2m: **905409**



ABSOLUTE



Installed on optional bore gage probe (page 14)

Bore Gage ABSOLUTE Digimatic Indicator ID-C

- > Hold automatically picks up hole diameter after a sweep.
- > Bore Gage Digimatic Indicator features both a key lock and parameter lock.
- > Fast measurement frequency up to 50 per second.
- > An analog bar indicator is integrated to enhance the intuition in reading.
- > Up to three sets of master values and upper/lower tolerance values can be memorized.

- > Go/no-go judgment
- > Employing the ABSOLUTE linear encoder, the ID-C always displays the spindle Absolute Position from the origin at power-on.
- > Improved parameter setting software makes it even easier to set all of the available parameters and determine and upload the proper coefficients for calculation. (optional) **21EZA313**

MeasurLink ENABLED
Data Management Software by Mitutoyo



Order No.	Resolution	Range	Accuracy	Measuring Force	List	Promo
543-312B	.00005/.0001/.0005"	.5"/12.7mm	±.00010"/0.003mm	1.5N or less	\$445.00	\$400.50

SPC cable – 1m: **905338** 2m: **905409**



ABSOLUTE

Peak Hold ABSOLUTE Digimatic Indicator ID-C

With Max./Min. Value Holding Function

- > Peak Hold Digimatic Indicator features both a Key Lock and Parameter Lock.
- > An analog bar provides easy-to-read values when scanning for Max, Min and TIR Values.
- > Go/no-go judgment
- > The maximum, minimum or runout value can be displayed during measurement.

- > Fast measurement frequency up to 50 per second.
- > Employing the ABSOLUTE linear encoder, the Signal ID-C always displays the spindle Absolute Position from the origin at power-on.
- > Improved parameter setting software makes it even easier to set all of the available parameters and determine and upload the proper coefficients for calculation. (optional) **21EZA313**

MeasurLink ENABLED
Data Management Software by Mitutoyo



Order No.	Resolution	Range	Accuracy	Remarks	List	Promo
Stem dia. 3/8", #4-48 UNF Thread						
543-302	.00005/.0001/.0005"	.5"/12.7mm	±.00010"/0.003mm	w/lug	\$445.00	\$400.50
543-302B	(0.001/0.01mm)	.5"/12.7mm	±.00010"/0.003mm	Flat-back	\$445.00	\$400.50
	Selectable					

SPC cable – 1m: **905338** 2m: **905409**



ABSOLUTE

QuantuMike Micrometer 4X Faster Spindle Travel

- > Faster measurement with 2mm travel per revolution instead of the standard 0.5mm.
- > A patented ratchet thimble mechanism helps ensure repeatability.
- > Function-lock system prevents inadvertent setting changes.
- > Long battery life – 2.4 years under normal operation.
- > Certificate of inspection provided.



www.mitutoyo.com/qm4x
VIDEO DEMO

MeasurLink ENABLED
Data Management Software by Mitutoyo

COOLANT PROOF™

Order No.	Range	Resolution	List	Promo
293-180-30*	0-1"/0 - 25.4mm	.00005"/0.001mm	\$262.00	\$248.90
293-185-30	0-1"/0 - 25.4mm	.00005"/0.001mm	\$226.00	\$214.70
293-181-30*	1-2"/25.4 - 50.8mm	.00005"/0.001mm	\$300.00	\$285.00
293-186-30	1-2"/25.4 - 50.8mm	.00005"/0.001mm	\$258.00	\$245.10
293-182-30*	2-3"/50.8 - 76.2mm	.00005"/0.001mm	\$358.00	\$340.10
293-187-30	2-3"/50.8 - 76.2mm	.00005"/0.001mm	\$310.00	\$294.50
293-183-30*	3-4"/76.2 - 101.6mm	.00005"/0.001mm	\$385.00	\$365.75
293-188-30	3-4"/76.2 - 101.6mm	.00005"/0.001mm	\$372.00	\$353.40

*with SPC Output

SPC cable with data switch – 1m: **05CZA662** 2m: **05CZA663**

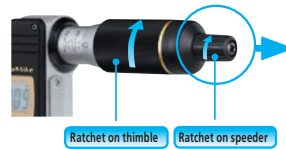

Significant reduction in positioning time

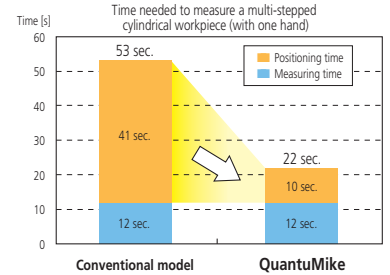

NEW Tool Kit

Tool Kit includes:

- QuantuMike **293-185-30**
- Digimatic Caliper **500-196-30**
- Mahogany Case **64PPP932**

\$368.10 Promo

\$409.00 List Price
Order No. **64PKA152**



MDC Micrometer

- > New electromagnetic ABSOLUTE sensor - Improved resistance to environmental conditions such as dirt, oil and water, which can cause false readings.
- > New ratchet thimble on select models improves one-hand operability.
- > New anti-slip finish for improved grip while taking measurements.
- > Long battery life – 2.4 years under normal operation.
- > Fully compatible with existing Mitutoyo Digimatic peripherals (SPC Cables, U-Wave wireless transmitters, DP1-VR, etc.) – SPC output-enabled IP65 models.
- > Function-lock system prevents inadvertent setting changes.
- > Certificate of inspection provided.



www.mitutoyo.com/MDC
VIDEO DEMO

COOLANT PROOF™

Order No.	Range	Resolution	Remarks	List	Promo
293-330-30*	0-1"/0-25.4mm	.00005"/0.001mm	Ratchet Stop	\$240.00	\$228.00
293-340-30	0-1"/0-25.4mm	.00005"/0.001mm	Ratchet Stop	\$187.00	\$177.65
293-344-30	0-1"/0-25.4mm	.00005"/0.001mm	Ratchet Thimble	\$187.00	\$177.65
293-348-30	0-1"/0-25.4mm	.00005"/0.001mm	Friction Thimble	\$187.00	\$177.65
293-349-30	0-1"/0-25.4mm	.0001"/0.001mm	Ratchet Thimble	\$187.00	\$177.65
293-331-30*	1-2"/25.4-50.8mm	.00005"/0.001mm	Ratchet Stop w/Standard	\$283.00	\$268.85
293-341-30	1-2"/25.4-50.8mm	.00005"/0.001mm	Ratchet Stop w/Standard	\$243.00	\$230.85
293-345-30	1-2"/25.4-50.8mm	.00005"/0.001mm	Ratchet Thimble w/Standard	\$243.00	\$230.85

*with SPC Output

SPC cable with data switch – 1m: **05CZA662** 2m: **05CZA663**



Low Force/Adjustable Force Micrometer

Suitable for soft or hard materials

- > Constant and low measuring force mechanism in the thimble.
- > Adjustable measuring force* accommodates various types of work materials. (*0.5-2.5N or 2-10N)
- > The measurement-value hold function automatically retains the data at a specified measuring force, ensuring accuracy.
- > Non-rotating spindle and the new ratchet friction thimble.
- > Speedy spindle feed: by .4"/rev.
- > With a standard bar to set the origin point (except for 0-.6", and 0-.4" models).
- > Resolution: .00005"/0.001mm Accuracy: ±.0001"



MeasurLink ENABLED
Data Management Software by Mitutoyo

ABSOLUTE
Analog System Powered by MITUTOYO

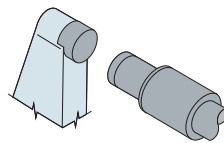

Low force models for soft materials

Order No.	Range	Measuring Force	List	Promo
227-211	0-.6"	0.5-2.5 (0.5, 1.0, 1.5, 2, 2.5) N	\$855.00	\$812.25
227-213	.6-1.2"	0.5-2.5 (0.5, 1.0, 1.5, 2, 2.5) N	\$901.00	\$855.95
227-215	0-.4"	2-10 (2, 4, 6, 8, 10) N	\$811.00	\$770.45
227-216	.4-.8"	2-10 (2, 4, 6, 8, 10) N	\$847.00	\$804.65
227-217	.8-1.2"	2-10 (2, 4, 6, 8, 10) N	\$874.00	\$830.30

SPC cable – 1m: 937387 2m: 965013

YouTube

Watch our videos on Specialty Calipers & Micrometers on our YouTube channel:
<http://www.mitutoyo.com/ytplaylist>



September 10 – 15, 2018
McCormick Place | Chicago, IL
VISIT US AT BOOTH E-5214

Spline Micrometer

- > The anvil and spindle have a small diameter for measuring splined shafts, slots and keyways.
- > With SPC output
- > With a standard bar except 0-1"
- > Resolution: .00005"/0.001mm

MeasurLink ENABLED
Data Management Software by Mitutoyo



Digital

Order No.	Range	Accuracy	Contacts	List	Promo
331-351-30	0 - 1" / 0 - 25.4mm	±.0001"	Ø.118"	\$470.00	\$446.50
331-361-30		±.0001"	Ø.079"	\$470.00	\$446.50
331-352-30	1 - 2" / 25.4-50.8mm	±.0001"	Ø.118"	\$527.00	\$500.65
331-362-30		±.0001"	Ø.079"	\$527.00	\$500.65
331-353-30	2 - 3" / 50.8-76.2mm	±.0001"	Ø.118"	\$571.00	\$542.45
331-363-30		±.0001"	Ø.079"	\$549.00	\$521.55
331-354-30	3 - 4" / 76.2-101.6mm	±.00015"	Ø.118"	\$661.00	\$627.95
331-364-30		±.00015"	Ø.079"	\$577.00	\$548.15

SPC cable with data switch – 1m: 05CZA662 2m: 05CZA663

Spherical Face Micrometer

- > Designed to measure the wall thickness of various tubing.
- > Resolution: .00005" / 0.001mm
- > With SPC output.
- > With a standard bar except 0-1" model.
- > With digit counter.



MeasurLink ENABLED
Data Management Software by Mitutoyo

Digital model with spherical anvil

Order No.	Range	Accuracy	Min ID	List	Promo
395-371-30 ^{S-S}	0 - 1" / 0 - 25.4mm	±.0001"	D: .59"	\$410.00	\$389.50
395-372-30 ^{S-S}	1" - 2" / 25.4- 50.8mm	±.0001"	D: .59"	\$435.00	\$413.25
395-373-30 ^{S-S}	2" - 3" / 50.8-76.2mm	±.0001"	D: .75"	\$494.00	\$469.30
395-374-30 ^{S-S}	3" - 4" / 76.2-101.6mm	±.00015"	D: .79"	\$527.00	\$500.65
395-351-30 ^{S-F}	0 - 1" / 0 - 25.4mm	±.0001"	D: .59"	\$397.00	\$377.15
395-352-30 ^{S-F}	1" - 2" / 25.4- 50.8mm	±.0001"	D: .59"	\$425.00	\$403.75
395-353-30 ^{S-F}	2" - 3" / 50.8-76.2mm	±.0001"	D: .75"	\$482.00	\$457.90
395-354-30 ^{S-F}	3" - 4" / 76.2-101.6mm	±.00015"	D: .79"	\$516.00	\$490.20

S-F: Spherical anvil and flat spindle
S-S: Spherical anvil and spherical spindle

SPC cable with data switch – 1m: 05CZA662 2m: 05CZA663

Point Micrometer

- > Pointed spindle and anvil for measuring the web thickness of drills, small grooves, keyways and other hard-to-reach dimensions.
- > The measuring points have approximately 0.3mm / .012" radius.
- > With a standard bar except 0 - 1"
- > Resolution: .00005" / 0.001mm (digital models)
- > With SPC output.
- > With carbide tips

MeasurLink ENABLED
Data Management Software by Mitutoyo

IP65 SPC



Digital

Order No.	Range	Accuracy	Point	List	Promo
342-351-30	0 - 1" / 0 - 25.4mm	±.0001"	15°	\$462.00	\$438.90
342-361-30	0 - 1" / 0 - 25.4mm	±.0001"	30°	\$462.00	\$438.90
342-352-30	1" - 2" / 25.4 - 50.8mm	±.0001"	15°	\$515.00	\$489.25
342-362-30	1" - 2" / 25.4 - 50.8mm	±.0001"	30°	\$504.00	\$478.80
342-353-30	2" - 3" / 50.8 - 76.2mm	±.0001"	15°	\$537.00	\$510.15
342-363-30	2" - 3" / 50.8 - 76.2mm	±.0001"	30°	\$537.00	\$510.15
342-354-30	3" - 4" / 76.2 - 101.6mm	±.00015"	15°	\$571.00	\$542.45
342-364-30	3" - 4" / 76.2 - 101.6mm	±.00015"	30°	\$571.00	\$542.45

SPC cable with data switch - 1m: **05CZA662** 2m: **05CZA663**

Tube Micrometer

- > Used to measure the wall thickness on tubing, pipe and other hard-to-reach places. Spherical or cylindrical anvils are available.
- > IP65 water/dust protection
- > With SPC output.

MeasurLink ENABLED
Data Management Software by Mitutoyo

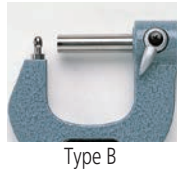

Type B



Type C

Type D

IP65 SPC

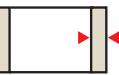

Anvil Type C



Digital

Order No.	Range	Resolution	Accuracy	Type	List	Promo
395-362-30	0 - 1" / 0 - 25.4mm	.00005" / 0.001mm	±.00015"	B	\$438.00	\$416.10
395-363-30	0 - 1" / 0 - 25.4mm	.00005" / 0.001mm	±.00015"	C	\$451.00	\$428.45
395-364-30	0 - 1" / 0 - 25.4mm	.00005" / 0.001mm	±.00015"	D	\$451.00	\$428.45

SPC cable with data switch - 1m: **05CZA662** 2m: **05CZA663**

Uni-Mike

- > Measures tubing thickness, shoulder-edge distance, rivet head height, etc. with interchangeable anvils (flat anvil, rod anvil, V-anvil).
- > IP65 water/dust protection.
- > Supplied with flat anvil (201216) and rod anvil: .118"/ø3mm dia. rod anvil (201217) for 0-1" models, .197"/ø5mm (201379) for 1-2"
- > With special optional disk anvils, the Uni-Mike can be used as a height micrometer.
- > With a standard bar except 0 - 1" model.

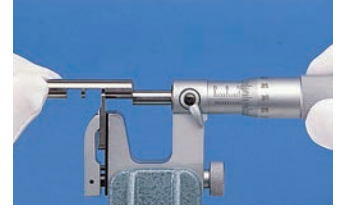

MeasurLink ENABLED
Data Management Software by Mitutoyo

IP65 SPC



Digital

Order No.	Range	Resolution	Accuracy	List	Promo
317-351-30	0 - 1" / 0 - 25.4mm	.00005" / 0.001mm	±.0002"	\$529.00	\$502.55
317-352-30	1 - 2" / 25.4 - 50.8mm	.00005" / 0.001mm	±.0002"	\$538.00	\$511.10

SPC cable with data switch - 1m: **05CZA662** 2m: **05CZA663**

QuickMike

- > Non-rotating spindle and the new ratchet friction thimble.
- > Speedy spindle feed: .4"/rev.
- > With absolute linear encoder.
- > IP54 dust/water protection (when not connected with data output cable).
- > With SPC data output.
- > With a standard bar to set the origin point (except 0 - 1.2").



293-676

ABSOLUTE
Absolute System Powered by MITUTOYO



293-679

MeasurLink ENABLED
Data Management Software by Mitutoyo

SPC IP54

Order No.	Range	Resolution	Accuracy	List	Promo
293-676	0 - 1.2" / 0 - 30.48mm	.00005" / 0.001mm	±.0001"	\$593.00	\$563.35
293-677	1" - 2.2" / 25.4 - 55.88mm	.00005" / 0.001mm	±.0001"	\$648.00	\$615.60
293-678	2" - 3.2" / 50.8 - 81.28mm	.00005" / 0.001mm	±.00015"	\$705.00	\$669.75
293-679	3" - 4.2" / 76.2 - 106.68mm	.00005" / 0.001mm	±.00015"	\$769.00	\$730.55

SPC cable - 1m: **937387** 2m: **965013**

Outside Micrometer with Interchangeable Anvils

- > Large range micrometers have an oversize frame and multiple anvils to allow a single micrometer to be used over a 6" range. This reduces tool cost for infrequently measured ranges.
- > Wide measuring range with interchangeable anvils.
- > Supplied with zero-setting standards bar for each range.

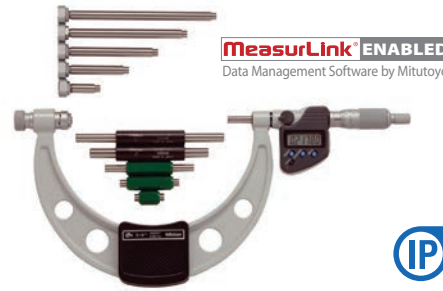

Order No.	Range	Resolution	List	Promo
340-351-30	0-6" / 0-152.4mm	.0005" / 0.001mm	\$732.00	\$695.40
340-352-30	6-12" / 152.4 - 304.8mm	.0001" / 0.001mm	\$900.00	\$855.00
340-720*	12-18" / 304.8 - 457.2mm	.0001" / 0.001mm	\$1,130.00	\$1,073.50
340-721*	18-24" / 457.2 - 609.6mm	.0001" / 0.001mm	\$1,280.00	\$1,216.00
340-722*	24-30" / 609.6 - 762.0mm	.0001" / 0.001mm	\$1,420.00	\$1,349.00
340-723*	30-36" / 762.0 - 914.4mm	.0001" / 0.001mm	\$1,500.00	\$1,425.00

SPC cable with data switch – 1m: **05CZA662** 2m: **05CZA663**
* 1m: **959149** 2m: **959150**

SPC Connecting Cables (optional)

Order No.	Description	List
With Data Out Switch		
05CZA662	1m — IP65 Micrometers	\$83.80
05CZA663	2m — IP65 Micrometers	\$92.45
959149	1m - Non IP Calipers, Large Micrometers	\$49.25
959150	2m - Non IP Calipers, Large Micrometers	\$55.20



05CZA662: 1m (40")
05CZA663: 2m (80")



959149: 1m (40")
959150: 2m (80")

U-Wave Wireless System

U-WAVE is a wireless system that connects to a gage with SPC Output. The data is sent to a receiver that is connected to a PC through USB connection.

Model	USB-ITN-A	USB-ITN-B	USB-ITN-C	USB-ITN-D	USB-ITN-E	USB-ITN-F	USB-ITN-G
Order No.	06ADV380A	06ADV380B	06ADV380C	06ADV380D	06ADV380E	06ADV380F	06ADV380G
Whether the existence of a data switch affects usability	Incorporates a data switch, so the tool is usable regardless of whether or not the measuring instrument has a switch.			Does not incorporate a data switch, so an instrument fitted with a switch is required in order to use the instrument alone. (However, the tool can be used with USB-ITPAK.)			
Cable type	A Water-proof with switch	B Water-proof with switch	C With switch	D 10-pin plain	E 6-pin round	F Straight type	G Water-proof straight type
Illustration of the plug that connects to the measuring instrument							
Socket type on the measuring instrument							

- > 2.4 GHz ZigBee wireless with a 60ft range.
- > HID compatible (Keyboard Entry) and Serial(VCP).
- > Supports Mitutoyo Digimatic or Digimatic 2 Type A, B, C, D, E, F, G.
- > Includes U-WAVEPAK Setup Software.

Software Requirements

- > Windows 7, 8 or 10.
- > 32 or 64 Bit

Order No.	Description	List	Promo
02AZD730G	U-WAVE-T/IP67 TYPE	\$220.00	\$209.00
02AZD880G	U-WAVE-T/BUZZER TYPE	\$220.00	\$209.00
02AZD810D	U-WAVE-R	\$499.00	\$474.05
02AZD790A	U-WAVE CONNECTING CABLE A	\$110.00	\$104.50
02AZD790B	U-WAVE CONNECTING CABLE B	\$110.00	\$104.50
02AZD790C	U-WAVE CONNECTING CABLE C	\$110.00	\$104.50
02AZD790D	U-WAVE CONNECTING CABLE D	\$110.00	\$104.50
02AZD790E	U-WAVE CONNECTING CABLE E	\$110.00	\$104.50
02AZD790F	U-WAVE CONNECTING CABLE F	\$110.00	\$104.50
02AZD790G	U-WAVE CONNECTING CABLE G	\$110.00	\$104.50



02AZD810D



ABSOLUTE Coolant-Proof Calipers

- > Sealed housing is IP-67 rated, meaning it's immune to the coolants, dirt, grit and chips found in many manufacturing environments.
- > Easy to use - no need to wipe or clean the scale.
- > .0005"/0.01mm resolution with ± 0.001 " accuracy.
- > Automatic power-on/off.
- > Certificate of inspection provided.



Built-in ABS (absolute) scale means that these calipers are ready to use immediately after power-on without origin resetting. It's as easy as vernier caliper measurements.

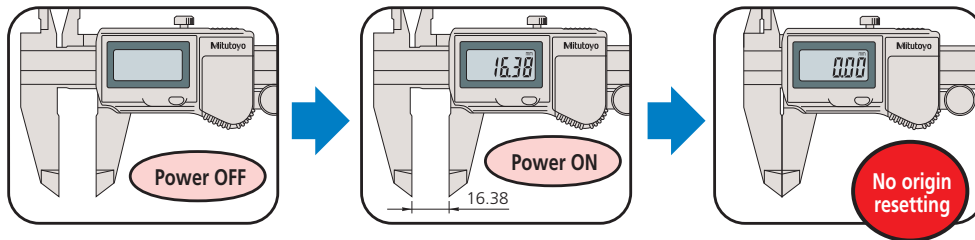

Order No.	Range	List	Promo
Non-Output Style			
500-752-20	0-6"/0-150mm	\$209.00	\$198.55
500-753-20	0-8"/0-200mm	\$280.00	\$266.00
500-754-10*	0-12"/0-300mm	\$484.00	\$459.80
SPC Output Style			
500-762-20	0-6"/0-150mm	\$248.00	\$235.60
500-763-20	0-8"/0-200mm	\$312.00	\$296.40
500-764-10*	0-12"/0-300mm	\$537.00	\$510.15

* ± 0.0015 " accuracy

SPC cable - 1m: 05CZA624 2m: 05CZA625



COOLANT PROOF™ IP67

COOLANTPROOF is the universal term of Mitutoyo Digimatic Small Tool Instruments that are free from measurement error and physical deterioration due to routine exposure to water, cutting oil or coolant. This high performance is achieved by using encoders that are inherently immune to contamination, where exposure is inevitable, combined with comprehensive sealing techniques and extremely oil-resistant materials to guarantee a long working life under normal operating conditions.

Digimatic Carbon-Fiber Caliper



Order No.	Range	Accuracy	Resolution	List	Promo
552-312-10	0(.5")-18"	+/- .002"	.0005"/0.01mm	\$947.00	\$899.65
552-313-10	0(.5")-24"	+/- .002"	.0005"/0.01mm	\$1,060.00	\$1,007.00
552-314-10	0(1")-40"	+/- .002"	.0005"/0.01mm	\$1,890.00	\$1,795.50
552-315-10	0(1")-60"	+/- .004"	.0005"/0.01mm	\$2,260.00	\$2,147.00
552-316-10	0(1")-80"	+/- .005"	.0005"/0.01mm	\$3,540.00	\$3,363.00

SPC cable - 1m: 05CZA624 2m: 05CZA625

- > Lightweight Digimatic Calipers that employ CFRP (Carbon Fiber Reinforced Plastics) in the beam and jaws.
- > Highly durable and easy to handle.
- > Direct readout of ID measurements from the LCD. (Offset value can be set easily by pressing the Offset key.)
- > Preset function for setting a desired starting point.
- > With SPC data output.
- > Special models available with ceramic jaws which are suitable for measuring abrasive and magnetic products.
- > Can be used in workshop conditions exposed to coolant, water, dust or oil.
- > Incorporates absolute measurement system.
- > Automatic power-on/off.

Prices effective April 2 through June 29, 2018

ABSOLUTE Digimatic Calipers

MeasurLink ENABLED
Data Management Software by Mitutoyo

- > Electromagnetic inductive sensor improves environmental resistance against dirt, water and oil.
- > A battery life of approximately 3.5 years has been achieved under normal use through the adoption of Mitutoyo's ABSOLUTE scale.
- > The slider configuration features an ergonomic, thumb-friendly shape.
- > Step-measurement capable.
- > The data output function allows integration into statistical process control and measurement systems.
- > Display character height: 9mm
- > AOS applies to 4", 6" and 8" models
- > Resolution: .0005"/0.01mm



www.mitutoyo.com/aoscd
VIDEO DEMO



500-196-30



AOS: Advanced Onsite Sensor

Order No.	Range	Remarks	List	Promo
No SPC Output Style				
500-195-30	0-4" / 0-100mm	.075" Round depth bar	\$144.00	\$136.80
500-196-30	0-6" / 0-150mm		\$156.00	\$148.20
500-197-30	0-8" / 0-200mm		\$224.00	\$212.80
500-193	0-12" / 0-300mm		\$450.00	\$427.50
With SPC Output Style				
500-170-30	0-4" / 0-100mm	.075" Round depth bar	\$172.00	\$163.40
500-171-30	0-6" / 0-150mm		\$183.00	\$173.85
500-172-30	0-8" / 0-200mm		\$241.00	\$228.95
500-173	0-12" / 0-300mm		\$525.00	\$498.75
500-505-10	0-18" / 0-450mm	Without Thumb Roller	\$819.00	\$778.05
500-506-10	0-24" / 0-600mm	Without Thumb Roller	\$900.00	\$855.00
500-507-10	0-40" / 0-1000mm	Without Thumb Roller	\$1,740.00	\$1,653.00

SPC cable with data switch – 1m: 959149 2m: 959150

Dial Calipers

- > Smooth sliding and high shock protection.
- > Lock screw for dial bezel and for holding the sliding jaw position.
- > Can measure OD, ID, depth and steps.
- > Models available with carbide-tipped OD and ID jaws.

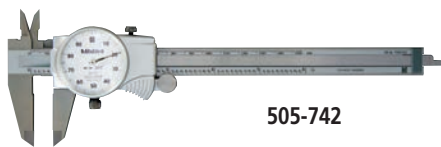

505-742

Order No.	Range	Remarks	List	Promo
505-742	6" .100"/rev.		\$121.00	\$108.90
505-738	6" .100"/rev.	Carbide-Tipped Jaws	\$207.00	\$186.30
505-740	6" .200"/rev.		\$111.00	\$99.90
505-743	8" .100"/rev		\$177.00	\$159.30
505-746	12" .100/rev		\$281.00	\$252.90
505-749	12" .200/rev		\$261.00	\$234.90
505-742-56	6" .100"/rev.	Black dial face	\$121.00	\$108.90

Coolant-Proof Carbon-Fiber Caliper with Interchangeable Jaws

- > The range of applications can be expanded by using interchangeable jaws (optional).
- > Quick and easy change of jaws due to the unique clamping mechanism. (A pair of clamping wheels is a standard accessory.)
- > Provided with preset function for setting a desired starting point, which allows direct readout of offset measurements.
- > Resolution: .0005"/0.01mm

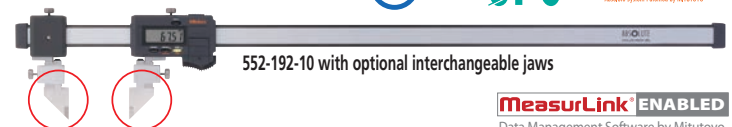

552-192-10 with optional interchangeable jaws

MeasurLink ENABLED
Data Management Software by Mitutoyo

Order No.	Range	Accuracy	List	Promo
552-191-10	0 - 18" / 0 - 450mm	±.002"	\$910.00	\$864.50
552-192-10	0 - 24" / 0 - 600mm	±.002"	\$940.00	\$893.00
552-193-10	0 - 40" / 0 - 1000mm	±.002"	\$1,510.00	\$1,434.50
552-194-10	0 - 60" / 0 - 1500mm	±.004"	\$2,450.00	\$2,327.50
552-195-10	0 - 80" / 0 - 2000mm	±.005"	\$3,430.00	\$3,258.50

SPC cable with data switch – 1m: 05CZA624 2m: 05CZA625

Interchangeable Jaws (optional)

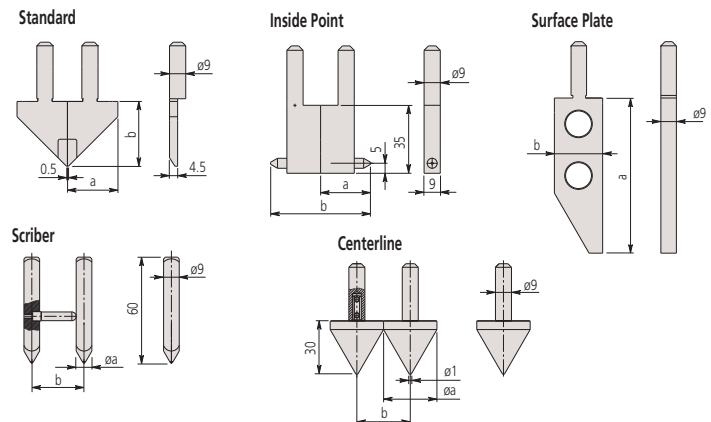

Order No.	Components	a	b	List	Promo
Standard					
07CZA056	Right (07CAA044), Left (07CAA045)	28mm (1.1")	30mm (1.2")	\$308.00	\$292.60
Inside Point					
07CZA058	07CZA041 x 2pcs.	25mm	50mm	\$317.00	\$301.15
07CZA059	07CZA048 x 2pcs.	1"	2"	\$342.00	\$324.90
Scriber					
07CZA055	Right (07CZA042), Left (07CZA043)	8mm	30mm	\$335.00	\$318.25
07CZA061	Right (07CZA042), Left (07CZA049)	.31"	1.2"	\$342.00	\$324.90
Surface Plate					
07CZA044		3.5" / 90mm	1.1" / 28mm	\$267.00	\$253.65
Centerline					
07CZA057	07CZA039 x 2pcs.	30mm	30mm	\$342.00	\$324.90
07CZA060	07CZA047 x 2pcs.	1.2"	1.2"	\$317.00	\$301.15

Offset Caliper

- > Main scale jaw can slide up and down to facilitate measurement of stepped sections. (Hard-to-reach dimensions such as A, B, C can be accurately measured.)
- > With depth bar.
- > With SPC data output.

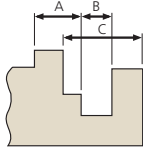

MeasurLink ENABLED Data Management Software by Mitutoyo **IP67** **SPC** **ABSOLUTE** Absolute System Powered by MITUTOYO

Order No.	Range	Accuracy	Resolution	List	Promo
573-701-20	0 - 6" / 0 - 150mm	±.001"	.0005" / 0.01mm	\$464.00	\$440.80
573-702-20	0 - 8" / 0 - 200mm	±.001"	.0005" / 0.01mm	\$532.00	\$505.40
573-704	0 - 12" / 0 - 300mm	±.0015"	.0005" / 0.01mm	\$714.00	\$678.30

SPC cable with data switch - 1m: **05CZA624** 2m: **05CZA625**

Point Caliper

- > Narrow tip jaws fit into very small grooves and tracks, making many previously difficult outside measurements easier to obtain.
- > With depth bar.
- > With SPC data output.

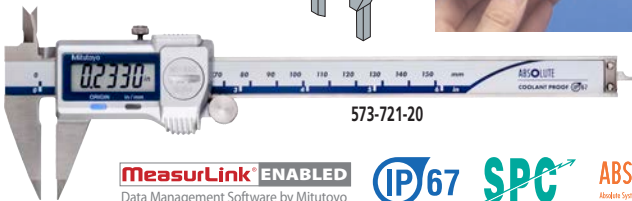
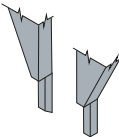

MeasurLink ENABLED Data Management Software by Mitutoyo **IP67** **SPC** **ABSOLUTE** Absolute System Powered by MITUTOYO

Order No.	Range	Accuracy	Resolution	List	Promo
573-721-20	0 - 6" / 0 - 150mm	±.001"	.0005" / 0.01mm	\$407.00	\$386.65
573-725-20*	0 - 6" / 0 - 150mm	±.001"	.0005" / 0.01mm	\$505.00	\$479.75

* Extended tips

SPC cable with data switch - 1m: **05CZA624** 2m: **05CZA625**

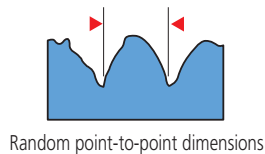
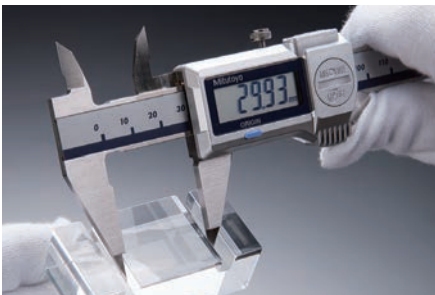

Random point-to-point dimensions

Neck Caliper

- > Point-jaw type can measure wall thickness inside bores and recesses.
- > Flat-jaw type can measure grooves and recesses.
- > With SPC data output.

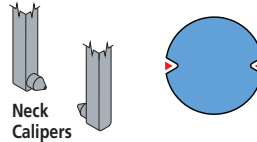
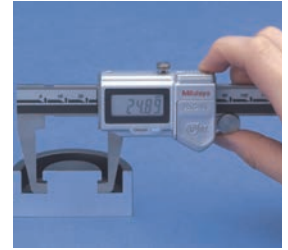
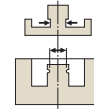

Neck Calipers

MeasurLink ENABLED Data Management Software by Mitutoyo

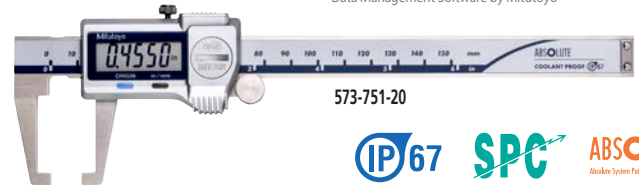

IP67 **SPC** **ABSOLUTE** Absolute System Powered by MITUTOYO

Order No.	Range	Accuracy	Resolution	List	Promo
573-751-20	0 - 6" / 0 - 150mm	±.0015"	.0005" / 0.01mm	\$667.00	\$633.65
573-752-20*	0 - 6" / 0 - 150mm	±.0015"	.0005" / 0.01mm	\$802.00	\$761.90

*Point jaw

SPC cable with data switch - 1m: **05CZA624** 2m: **05CZA625**

Low-Force Caliper

- > Due to the low measuring force these calipers are ideal for elastic or resilient workpieces such as plastic parts and rubber parts that standard calipers can't measure consistently.
- > With SPC data output.



Measurement procedures



To measure resilient workpieces, take the measurement when the pointer is between the two index lines.

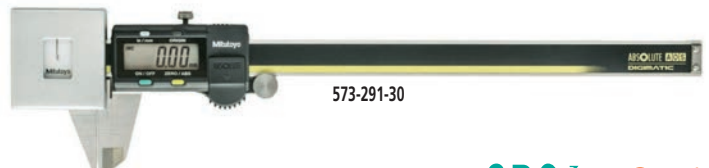

MeasurLink ENABLED Data Management Software by Mitutoyo **SPC** **ABSOLUTE** Absolute System Powered by MITUTOYO

Order No.	Range	Accuracy	Resolution	List	Promo
573-291-30	0 - 7" / 0 - 180mm	±.002"	.0005" / 0.01mm	\$820.00	\$779.00

SPC cable with data switch - 1m: **959149** 2m: **959150**

Digimatic Caliper with Nib-Style Jaws

- > The rounded faces of the jaws are ideal for accurate ID (inside diameter) measurement.
- > With SPC output.



550-341-10

MeasurLink ENABLED
Data Management Software by Mitutoyo

IP67 **SPC** **ABSOLUTE**
Absolute System Powered by MITUTOYO

SPC cable with data switch – 1m: **05CZA624** 2m: **05CZA625**

Order No.	Range*	Accuracy	Resolution	List	Promo
550-311-20	0 (.4") - 8" / 0 (10) - 200mm	±.001"	.0005" / 0.01mm	\$525.00	\$498.75
550-341-10	0 (.4") - 12" / 0 (10) - 300mm	±.0015"	.0005" / 0.01mm	\$763.00	\$724.85
550-223-10**	0 (.5") - 18" / 0 (20) - 450mm	±.002"	.0005" / 0.01mm	\$956.00	\$908.20
550-225-10**	0 (.5") - 24" / 0 (20) - 600mm	±.002"	.0005" / 0.01mm	\$1,070.00	\$1,016.50
550-227-10**	0 (1") - 40" / 0 (20) - 1000mm	±.003"	.0005" / 0.01mm	\$1,910.00	\$1,814.50

*() : Minimum dimension in ID measurement **Models are not IP67 rated

Digimatic Caliper with Nib and Standard Jaws

- > The rounded faces of the jaws are ideal for accurate ID (inside diameter) measurement.
- > With SPC output.

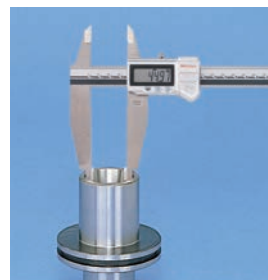

551-224-10

MeasurLink ENABLED
Data Management Software by Mitutoyo

IP67 **SPC**

Order No.	Range*	Accuracy	Resolution	List	Promo
551-311-20	0 (.4") - 8" / 0 (10) - 200mm	±.001"	.0005" / 0.01mm	\$579.00	\$550.05
551-341-10	0 (.4") - 12" / 0 (10) - 300mm	±.002"	.0005" / 0.01mm	\$829.00	\$787.55
551-224-10**	0 (.5") - 20" / 0 (20) - 500mm	±.0025"	.0005" / 0.01mm	\$1,220.00	\$1,159.00
551-226-10**	0 (.5") - 30" / 0 (20) - 750mm	±.0025"	.0005" / 0.01mm	\$1,980.00	\$1,881.00
551-227-10**	0 (1") - 40" / 0 (20) - 1000mm	±.003"	.0005" / 0.01mm	\$2,080.00	\$1,976.00

*() : Minimum dimension in ID measurement
** Models are not IP67 rated

SPC cable with data switch – 1m: **05CZA624** 2m: **05CZA625**

Inside Caliper Knife-Edge/Inside Groove/Point Jaw

- > Special ID jaw calipers are designed for difficult-to-measure areas, such as ID grooves or recessed areas.
- > With SPC data output.



IP67 **SPC** **ABSOLUTE**
Absolute System Powered by MITUTOYO

Knife edge



573-742-20

Measurable min. hole diameter: ϕ .4"

MeasurLink ENABLED
Data Management Software by Mitutoyo

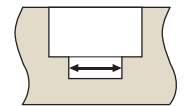

Inside groove



573-745-20

Measurable min. hole diameter: ϕ .4"

MeasurLink ENABLED
Data Management Software by Mitutoyo

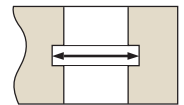

Point jaw



573-746-20

Measurable min. hole diameter: ϕ .8"

MeasurLink ENABLED
Data Management Software by Mitutoyo

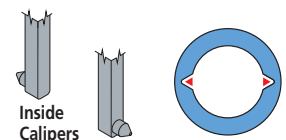
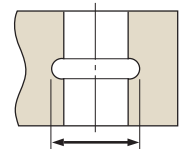

Order No.	Range	Accuracy	List	Promo
573-742-20	.4" - 8" / 10-200mm	±.002"	\$910.00	\$864.50
573-745-20	.4" - 6" / 10-150mm	±.002"	\$727.00	\$690.65
573-746-20	.8" - 6" / 20-150mm	±.0015"	\$883.00	\$838.85

SPC cable with data switch – 1m: **05CZA624** 2m: **05CZA625**

Digimatic Indicator ID-H

Remote programming capable

> This digital indicator offers the excellent accuracy and functionality expected from this class of indicator. Take advantage of its high accuracy backed up by 0.5µm / .00002" resolution, remote control functionality via a handheld controller (or an RS-232C interface) and easy runout measurements with the well-established analog bar display.

> The maximum, minimum or runout value can be displayed during measurement.
 > Go/no-go judgment is performed by setting the upper and lower tolerances. If a judgment result is out of tolerance, the display backlighting changes from green to red, so tolerance judgment can be made at a glance.
 > With RS-232C input/output

Stem dia. 3/8" #4-48 UNF Thread

Order No.	Resolution	Range	Model	Accuracy	List	Promo
543-562A	.00002", .00005", .0001", 0.0005mm,	1.2" / 30.4mm	ID-H530E	0.0015mm	\$883.00	\$794.70
543-564A	0.001mm	2.4" / 60.9mm	ID-H560E	0.0025mm	\$1,050.00	\$945.00

SPC cable – 1m: 936937 2m: 965014



MeasurLink ENABLED
Data Management Software by Mitutoyo

ABSOLUTE Digimatic Indicator ID-F

> With the ABSOLUTE linear encoder technology, once the measurement reference point has been preset, it will not be lost when the power is turned on.
 > Go/no-go judgment is performed by setting the upper and lower tolerances. If a judgment result is out of tolerance, the display backlighting changes from green to red, so tolerance judgment can be made at a glance.
 > The maximum, minimum or runout value can be displayed during measurement.

> An analog bar indicator has been integrated to handle upper/lower limit approaching and zero approaching. It enhances the ease of operation in the same manner as a dial indicator. The display range of the analog bar can be changed.



Stem dia. 3/8" #4-48 UNF Thread

Order No.	Resolution	Range	Model	Accuracy	List	Promo
543-552A	.00005", .0001", .0005", .001", 0.001mm,	1" / 25.4mm	ID-F125E	.00012"	\$667.00	\$600.30
543-558A	0.01mm	2" / 50.8mm	ID-F150HE	.00012"	\$773.00	\$695.70

SPC cable – 1m: 936937 2m: 965014



SPC

MeasurLink ENABLED
Data Management Software by Mitutoyo

ABSOLUTE Digimatic Indicator ID-U

> Slim digital indicator with low price.
 > Large LCD and simple key operation.
 > After the initial origin setting, the ID-U no longer needs absolute positioning over the entire battery life; the origin is remembered even after power-off.
 > Ideal for installation into measuring devices because of compact design and long battery life.
 > Employing the ABSOLUTE linear encoder, the ID-U always displays the spindle Absolute Position from the origin at power-on. Also unlimited response speed eliminates overspeed errors.
 > Flat-back type has no option for backs.

Order No.	Resolution	Range	Model	Accuracy	Measuring force	List	Promo
575-123	.0005"/0.01mm	1" / 25.4mm	ID-U1025E	.0008"	1.8N or less	\$195.00	\$175.50

SPC cable – 1m: 905338 2m: 905409



MeasurLink ENABLED
Data Management Software by Mitutoyo

ABSOLUTE Digimatic Indicator ID-S

- > Employing the ABSOLUTE linear encoder, the ID-S always displays the spindle Absolute Position from the origin at power-on. Also unlimited response speed eliminates overspeed errors.
- > Dust/Water protection level: IP42 (IP53: **543-794B, 543-795B, 543-796B**)
- > SPC data output.



MeasurLink ENABLED
Data Management Software by Mitutoyo



Order No.	Resolution	Range	Accuracy	Measuring force	Remarks	List	Promo
Stem dia. 3/8", #4-48 UNF Thread							
543-792	.00005"/0.001mm	.5" / 12.7mm	±.0001"	1.5N or less	w/ lug back	\$273.00	\$259.00
543-796	.00005"/0.001mm	.5" / 12.7mm	±.0001"	2.5N or less	w/ lug back	\$301.00	\$285.00
543-793	.0001"/0.001mm	.5" / 12.7mm	±.0001"	1.5N or less	w/ lug back	\$273.00	\$260.00
543-783	.0005"/0.01mm	.5" / 12.7mm	±.0010"	1.5N or less	w/ lug back	\$177.00	\$168.00
543-792B	.00005"/0.001mm	.5" / 12.7mm	±.0001"	1.5N or less	w/ flat-back	\$273.00	\$259.00
543-796B	.00005"/0.001mm	.5" / 12.7mm	±.0001"	2.5N or less	w/ flat-back	\$301.00	\$286.00
543-793B	.0001"/0.001mm	.5" / 12.7mm	±.0001"	1.5N or less	w/ flat-back	\$273.00	\$259.00
543-783B	.0005"/0.01mm	.5" / 12.7mm	±.0010"	1.5N or less	w/ flat-back	\$177.00	\$168.00
Stem ø 8mm, M2.5 x 0.45 Thread							
543-791	.00005"/0.001mm	.5" / 12.7mm	±.0001"	1.5N or less	w/ lug back	\$282.00	\$268.00
543-795	.00005"/0.001mm	.5" / 12.7mm	±.0001"	2.5N or less	w/ lug back	\$310.00	\$295.00
543-782	.0005"/0.01mm	.5" / 12.7mm	±.001"	1.5N or less	w/ lug back	\$177.00	\$168.00
543-791B	.00005"/0.001mm	.5" / 12.7mm	±.0001"	1.5N or less	w/ flat-back	\$282.00	\$268.00
543-795B	.00005"/0.001mm	.5" / 12.7mm	±.0001"	2.5N or less	w/ flat-back	\$310.00	\$295.00
543-782B	.0005"/0.01mm	.5" / 12.7mm	±.001"	1.5N or less	w/ flat-back	\$177.00	\$168.00

SPC cable – 1m: 905338 2m: 905409

IDC Digimatic Indicators

- > Absolute Encoder ensures all settings and readings maintained for the life of the battery (even when the power is turned off).
- > Preset, zero set, inch/mm, +/- direction and go/no-go functions.
- > Face rotates 330° for use at various angles.
- > Stem diameter: 3/8"
- > Immune to overspeed error.
- > SPC output provided.
- > Average battery life 7,000 hours using SR-44 battery (938882).

MeasurLink ENABLED
Data Management Software by Mitutoyo



Order No.	Range	Remarks	List	Promo
.0005"/0.01mm Resolution				
543-402	.500"/12.7mm	Lug Back	\$310.00	\$294.50
543-402B	.500"/12.7mm	Flat Back	\$310.00	\$294.50
543-476B	1"/25mm	Flat Back	\$454.00	\$431.30
543-496B	2"/50mm	Flat Back	\$597.00	\$567.15
.00005"/.0001"/.0005"/0.001mm/0.01mm selectable resolutions				
543-392	.500"/12.7mm	Lug Back	\$424.00	\$402.80
543-392B	.500"/12.7mm	Flat Back	\$424.00	\$402.80
543-472B	1"/25mm	Flat Back	\$568.00	\$539.60
543-492B	2"/50mm	Flat Back	\$713.00	\$677.35

SPC cable – 1m: 905338 2m: 905409



Now with multiplier function $f(x)=Ax$
(other models available with $Ax+B+Cx-1$
function; see page 13)

Bore Gages

- > Carbide-tipped contact points for durability.
- > The dial indicator is fully protected by a rugged cover.
- > Optional extension rods can be attached for measuring deep holes.

See digimatic indicators for bore gages (page 13)



Optional Accessories

- 953549:** 125mm / 4.92" Extension rod for 18-35mm / .7 - 1.4" models
- 953552:** 125mm / 4.92" Extension rod for 35-160mm / 1.4 - 6.5" models
- 953557:** 125mm / 4.92" Extension rod for 160-400mm / 6.5 - 16" models
- 953550:** 250mm / 9.84" Extension rod for 18-35mm / .7 - 1.4" models
- 953553:** 250mm / 9.84" Extension rod for 35-160mm / 1.4 - 6.5" models
- 952361:** 250mm / 9.84" Extension rod for 160-400mm / 6.5 - 16" models
- 953551:** 500mm / 19.69" Extension rod for 18-35mm / .7 - 1.4" models
- 953554:** 500mm / 19.69" Extension rod for 35-160mm / 1.4 - 6.5" models
- 953558:** 500mm / 19.69" Extension rod for 160-400mm / 6.5 - 16" models
- 953555:** 750mm / 29.53" Extension rod for 35-160mm / 1.4 - 6.5" models
- 953559:** 750mm / 29.53" Extension rod for 160-400mm / 6.5 - 16" models
- 953556:** 1000mm / 39.37" Extension rod for 35-160mm / 1.4 - 6.5" models
- 953560:** 1000mm / 39.37" Extension rod for 160-400mm / 6.5 - 16" models



511-751

Order No	Range	Graduation (Indicator)	Anvils	Spacers	List	Promo
511-751	.7 - 1.4"	.0001" (2923SB-10)	9	2	\$411.00	\$369.90
511-752	1.4 - 2.5"		6	4	\$401.00	\$360.90
511-753	2.0 - 6.0"		11 (2" sub anvil)	4	\$438.00	\$394.20
511-754	4.0 - 6.5"		13	4	\$579.00	\$521.10
511-755	6.5 - 10"		6	7	\$652.00	\$586.80
511-756	10 - 16"		5 (3" sub anvil)	7	\$776.00	\$698.40

Digimatic Holtest

- > TiN-coated measuring contact points provide excellent durability and impact resistance and allow the instrument to measure close to the bottom of blind holes (up to 100mm / 4" models).
- > Large LCD readout.
- > Functions available: Presetting, Zero/ABS, Auto power On/Off, Data hold, Data output, Error alarm, Battery replacement alarm.
- > With ratchet stop for constant force.
- > Measure deep holes by attaching an extension rod (optional).
- > Setting rings are included in sets, but optional for individual gages.
- > Supplied in fitted plastic case up to 100mm / 4". Over 100mm / 4" supplied in wooden case.
- > Resolution: .00005"/0.001mm (over 4" models: .0001"/0.001mm)

SAVE 20%

MeasurLink[®] ENABLED
Data Management Software by Mitutoyo



468-263



468-274



www.mitutoyo.com/dholtest
VIDEO DEMO



Order No	Range	Accuracy	List	Promo
468-261	.275 - .35" / 6.925 - 8.89mm	±.0001"	\$1,110.00	\$888.00
468-262	.35 - .425" / 8.89 - 10.795mm	±.0001"	\$1,110.00	\$888.00
468-263	.425 - .5" / 10.795 - 12.7mm	±.0001"	\$1,120.00	\$896.00
468-264	.5 - .65" / 12.7 - 16.51mm	±.0001"	\$1,220.00	\$976.00
468-265	.65 - .8" / 16.51 - 20.32mm	±.0001"	\$1,220.00	\$976.00
468-266	.8 - 1" / 20.32 - 25.4mm	±.00015"	\$1,250.00	\$1,000.00
468-267	1 - 1.2" / 25.4 - 30.48mm	±.00015"	\$1,250.00	\$1,000.00
468-268	1.2 - 1.6" / 30.48 - 40.64mm	±.00015"	\$1,280.00	\$1,024.00
468-269	1.6 - 2" / 40.64 - 50.8mm	±.00015"	\$1,290.00	\$1,032.00
468-270	2 - 2.5" / 50.8 - 63.5mm	±.00015"	\$1,400.00	\$1,120.00
468-271	2.5 - 3" / 63.5 - 76.2mm	±.00015"	\$1,400.00	\$1,120.00
468-272	3 - 3.5" / 76.2 - 88.9mm	±.00015"	\$1,420.00	\$1,136.00
468-273	3.5 - 4" / 88.9 - 101.6mm	±.00015"	\$1,440.00	\$1,152.00
468-274	4 - 5" / 101.6 - 127mm	±.0002"	\$1,880.00	\$1,504.00

Optional Accessories

- 04AZB157:** Mounting plate for stand
- 156-101-10:** Stand
- 952322:** Extension rod 100mm / 3.94"
For range 6-12mm / .275 - .5" models
- 952621:** Extension rod 150mm / 5.9"
For range 12-20mm / .5" - .8" models
- 952622:** Extension rod 150mm / 5.9"
For range 20-50mm / .8" - 2" models
- 952623:** Extension rod 150mm / 5.9"
For range 50-300mm / 2" - 12" models

Prices effective April 2 through June 29, 2018

QM-Height High-Precision ABSOLUTE Digital Height Gage

- > High-accuracy / high-resolution ABSOLUTE linear encoder for position detection
- > High-accuracy – $\pm(2.4 + 2.1L / 600)\mu\text{m}$
- > Pneumatic flotation system / positioning grip – allows for smooth movement along surface plate (select models)
- > Large, stationary display panel with user-friendly icon control keys and go/no-go LED indicator
- > Digital and USB output – Supports Mitutoyo wireless SPC output
- > Long battery life with standard AA batteries (4) – Up to 300 hours (80 hours with regular use of pneumatic flotation function)
- > Fully compatible with existing Mitutoyo Digimatic peripherals (SPC cables, U-Wave wireless transmitters, multiplexers, etc.)

Go/ \pm NG judgment by LED (red, orange, green) and measurement examples

- > LEDs are activated at the time of tolerance judgment – green for Go, red for +NG, and orange for -NG. -NG, GO and +NG also appear on the LCD.

Order No.	Range	Resolution	Remarks	List	Promo
64PKA094A	0 - 14" / 0 - 350mm			\$3,990.00	\$3,591.00
64PKA095A	0 - 24" / 0 - 600mm	0.001mm / 0.0005mm		\$4,490.00	\$4,041.00
64PKA129A	0 - 14" / 0 - 350mm	.00005" / .0001"	Pneumatic Flotation System	\$4,490.00	\$4,041.00
64PKA130A	0 - 24" / 0 - 600mm			\$4,990.00	\$4,491.00



MeasurLink ENABLED
Data Management Software by Mitutoyo

Digimatic Height Gages (Multi-Function)

Now with two resolutions (.0002"/.0005"), two-value preset memory and increased character height for easier viewing.

- > Highly versatile, multi-function type.
- > Carbide-tipped long scriber is provided.
- > Rigid construction ensures repeatable measurement.
- > Switchable resolution.
- > Coarse/fine feed switching.
- > With SPC data output.
- > Two preset reference heights.
- > Inclined handle improves slider ergonomics.
- > Zero/ABS setting (ABS and INC modes)
- > Two-value preset memory
- > Data/hold
- > \pm Counting
- > Inch/mm conversion



192-670-10

MeasurLink ENABLED
Data Management Software by Mitutoyo

Order No.	Range	Resolution	Accuracy	List	Promo
192-670-10	0-12" / 0-300mm	.0005" (0.01mm)	$\pm 001"$	\$1,770.00	\$1,681.50
192-671-10	0-18" / 0-450mm	[.0002" (0.005mm) Switchable]	$\pm 0015"$	\$2,280.00	\$2,166.00
192-672-10	0-24" / 0-600mm		$\pm 0015"$	\$2,920.00	\$2,774.00

Dial Height Gages

Double-column structure ensures high measuring accuracy. Coarse/fine feed switching. Carbide-tipped scriber.

- > Easy and error-free reading with both up and down digital counters, as well as a dial.
- > Provided with a feed wheel for easy coarse feeding.
- > Carbide-tipped scriber is provided.
- > The counters and dial can be re-zeroed at any scriber position.
- > Fits comfortably in the hand and moves easily on the surface plate.



Easy and error-free reading



192-150

Order No.	Range	Graduation	List	Promo
192-150	0-12"	.001"	\$1,010.00	\$959.50
192-151	0-18"	.001"	\$1,400.00	\$1,330.00
192-152	0 - 24"	.001"	\$1,820.00	\$1,729.00

Durometers (Digital and Analog) For Rubber and Plastics Hardness Testing

> Durometers are suitable for testing natural rubber, neoprene, polyesters, PVC, leather, Thiokol, nitril, wax, vinyl, cellulose acetates, glass, polystyrol and other materials.



Compact Dial
811-336-10



Compact Digital
811-336-10

MeasurLink ENABLED
Data Management Software by Mitutoyo

Order No	Model	Scale	Display	Graduation	Range	Indenter	List	Promo
811-335-10	HH-335	Shore A	Analog	1.0	10~90	Blunt Taper	\$599.00	\$569.05
811-336-10	HH-336	Shore A	Digital	0.5	10~90	Blunt Taper	\$1,280.00	\$1,216.00
811-337-10	HH-337	Shore D	Analog	1.0	20~90	Sharp Point	\$599.00	\$569.05
811-338-10	HH-338	Shore D	Digital	0.5	20~90	Sharp Point	\$1,280.00	\$1,216.00
64AAA964	Test Block Set (Shore A Scale)						\$188.00	\$178.60
64AAA590	Test Block Set (Shore D Scale)						\$188.00	\$178.60
64AAA962	A Scale Durometer Stand						\$959.00	\$911.05
64AAA796	D Scale Durometer Stand						\$2,500.00	\$2,375.00



HH-411 Hardmatic

Rebound portable hardness tester featuring reproducibility and ease of operation on large parts. It is lightweight and can be carried into the shop or out in the field.

MeasurLink ENABLED
Data Management Software by Mitutoyo



Order No.	Type	List	Promo
810-298-10	HH-411 Hardmatic	\$3,990	\$3,735

Model	HH-411		
Order No.	810-298-10		
Hardness Range	L-Value (ASTM A956)		
Detector	Input device D (carbide ball)		
Display	Hardness	Range	Resolution
	HL	1-999 HL	1 HL
	HV	43-950 HV	1 HV
	HB	20-894 HB	1 HB
	HRC	19.3-68.2 HRC	0.1 HRC
	HRB	13.5 - 101.7 HRB	0.1 HRB
	HS	13.2 - 99.3 HS	0.1 HS
	HTN	499 - 1996 Mpa	1 Mpa
Functions	Conversions: HL, HV, HB, HRC, HRB, HS, HTN Judgment: OK/NG Offsetting Memory: 1,800 data		
Output	RS-232C, SPC		
Power supply	Alkaline AA Battery 2pcs.		
Dimensions	Detector: (Dia. X H) 1.10" x 6.89" (28 x 175mm) Display: (W x D x H) 2.76" x 4.33" x 1.38" (70 x 110 x 35mm)		
Mass	Detector: .26lbs (120g) Display: .44lbs (200g)		



September 10 – 15, 2018
McCormick Place | Chicago, IL
VISIT US AT BOOTH E-5214

Rockwell and Rockwell Superficial Hardness Tester

With Real-Time Electronic Test Force Control



- › Closed-loop control of testing forces
- › Primary and final forces (loads) are applied with unparalleled accuracy and repeatability
- › Extended indenter arm reaches inside diameters and hard-to-reach surfaces at eye level, allowing the operator to easily see where the indenter accesses small or hard-to-reach parts
- › Automatic setting of preliminary test force and application of total test force
- › Indenter escape function allows automatic removal of preliminary test force at end of test cycle
- › Touch-screen operation with a back-lit LCD
- › Hardness scale is set automatically via the touch screen
- › Cylindrical and spherical surface compensation
- › Auto conversion to all hardness scales or tensile strength

MeasurLink ENABLED
Data Management Software by Mitutoyo



HR-530
(810-237)

Order No.	810-237	
Model	HR-530	
Hardness testing methods	Rockwell/Rockwell Superficial/Brinell/Plastics hardness	
Initial test force (N)	29.42N (3kgf), 98.07N (10kgf)	
Test force (N)	Rockwell Superficial	147.1N (15kgf), 294.2N (30kgf), 441.3N (45kgf)
	Rockwell	588.4N (60kgf), 980.7N (100kgf), 1471N (150kgf)
	Light Force Brinell	61.29 (6.25kgf), 98.07 (10kgf), 153.2 (15.625kgf), 245.2 (25kgf), 294.2 (30kgf), 306.5 (31.25kgf), 612.9 (62.5kgf), 980.7 (100kgf), 1226 (125kgf), 1839 (187.5kgf)
Test force control	Automatic (load/hold/unload)	
Table up/down mechanism	Manual (automatic braking and load sequencing)	
Test force switching	Operated with the display unit	
Test force hold time	1 to 120s (Selectable in units of 1s)	
Maximum specimen size	Height: 9.8" (250 mm)	
	Depth: 5.9" (150 mm)	
Permissible inside diameter of a tube specimen	Minimum hole diameter: 1.38" (35 mm) (when using the special indenter: .87" (22 mm))	
Display	Hardness value, test condition, go/no-go judgment result, statistical calculation result, X-R control chart, hardness conversion value	
	Conversion function [HV, HK, HR (Rockwell hardness A, B, C, D, F, G / Rockwell Superficial 15T, 30T, 45T, 15N, 30N, 45N), HS, HB, tensile strength]	
	Go/no-go judgment function	
	Continuous test function (for specimens with the same thickness)	
	Cylindrical correction, spherical correction, offset correction, multi-point correction functions	
External data output	Statistical calculation function (maximum value, minimum value, mean value, standard deviation, upper limit value, lower limit value, go count, range, no-go count)	
	Graph generation function (X-R control chart)	
External dimensions	Main unit	9.84" x 26.38" x 23.82" (250(W)x667(D)x621(H) mm)
	Touch-panel display	11.8" x 26.2" x 30.1" (300(W)x667(D)x766(H) mm)
Mass	Approx. 60 kg	
List	\$13,500.00	
Promo	\$12,500.00	

Function: Touch-screen type

- Touch-screen operation with a back-lit LCD graphic display.
- Remote selection of the test force linked to the hardness scale selection.
- Choice of language: English, German, French, Spanish, Italian and Japanese.
- Cylindrical and spherical surface compensation.
- Data offset.
- Conversion to other hardness scales.
- Powerful statistical processing with flexible data point editing and 1024 data memory.
- Measured data editing
- Go/no-go tolerance judgment.
- Statistical processing, histogram and \bar{x} -R chart

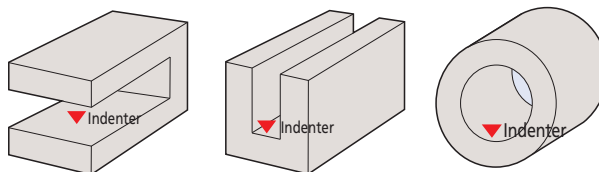

Various shapes of specimen can be measured. (Nose-type indenter axis mechanism has been adopted.) The nose-type indenter mechanism allows measurement of pipe samples as well as the top surface of a flat sample.

Quill Kit with Absolute Encoder

Easy Installation, Fits Most Vertical Knee Mills

- > Easy-to-read LCD with resolution of .0005"/0.01mm. 0 -6" travel.
- > Push-button controls for inch/mm, Zero-Set and On/Off.
- > Powered by a single SR-44 Battery which lasts about 1 year with normal use.
- > SPC Output for data transmission to data processors or a remote display.

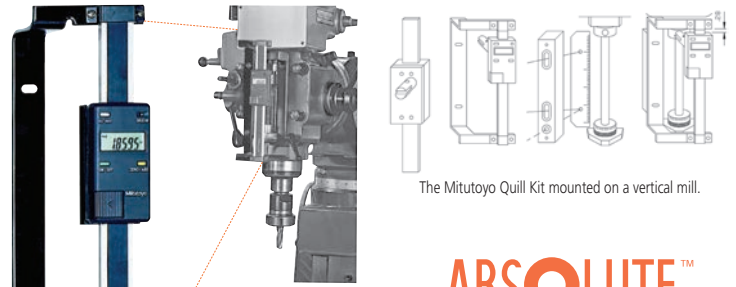

The Mitutoyo Quill Kit mounted on a vertical mill.

Order No.	Description	List	Promo
053906B	Digimatic Quill Kit complete with brackets & scale for Bridgeport Type machines.	\$310.00	\$279.00

MeasurLink ENABLED
Data Management Software by Mitutoyo

ABSOLUTE™

ABSOLUTE Digimatic Scale Units

- > The Origin key allows setting of an absolute zero point to be used as reference in subsequent measurements. Once set, the ABS Digimatic Scale Unit is ready to show its true position whenever turned on, rather than 0.00" as with standard models.
- > The Zero/ABS key allows the display to be zero-set at any slider position along the beam for incremental comparison measurements. This key will also allow return to the absolute coordinate with a display of the true position from the origin point.
- > No rack, no pinion, no glass scale. Digimatic scale unit is safely embedded in the hardened stainless steel blade.
- > Horizontal or vertical face according to the scale mounting direction.
- > Multi-function types with diameter displaying function are also available for lathes. (Contact Mitutoyo.)
- > All units come with two mounting brackets, each located at either end of the scale.
- > With SPC data output.

ABSOLUTE™

Order No	Model	Range	Accuracy	Resolution	Type	List	Promo
572-210-30	SD-4"DX	0-4" / 0-100mm	.001" / 0.03mm	.0005" / 0.01mm	Horizontal single-function	\$235.00	\$223.25
572-211-30	SD-6"DX	0-6" / 0-150mm	.001" / 0.03mm	.0005" / 0.01mm	Horizontal single-function	\$249.00	\$236.55
572-212-30	SD-8"DX	0-8" / 0-200mm	.001" / 0.03mm	.0005" / 0.01mm	Horizontal single-function	\$290.00	\$275.50
572-213-10	SD-12"D	0-12" / 0-300mm	.002" / 0.04mm	.0005" / 0.01mm	Horizontal single-function	\$559.00	\$531.05
572-310-10	SDV-6"D	0-4" / 0-100mm	.001" / 0.03mm	.0005" / 0.01mm	Vertical single function	\$260.00	\$247.00
572-311-10	SDV-6"D	0-6" / 0-150mm	.001" / 0.03mm	.0005" / 0.01mm	Vertical single-function	\$276.00	\$262.20
572-312-10	SDV-8"D	0-8" / 0-200mm	.001" / 0.03mm	.0005" / 0.01mm	Vertical single function	\$320.00	\$304.00
572-313-10	SDV-12"D	0-12" / 0-300mm	.002" / 0.04mm	.0005" / 0.01mm	Vertical single function	\$616.00	\$585.20



MeasurLink ENABLED
Data Management Software by Mitutoyo

Applications

Machine table position

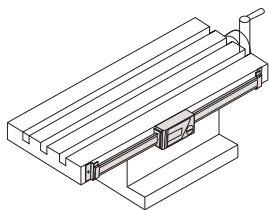

Drilling machine stroke position

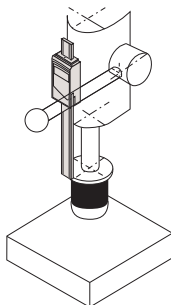

Focus setting on optical instruments

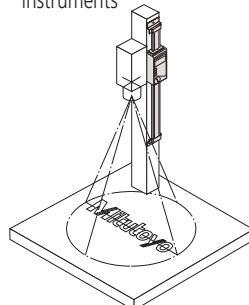

Special Applications

As a measurement jig for outdoor use (SD-G)

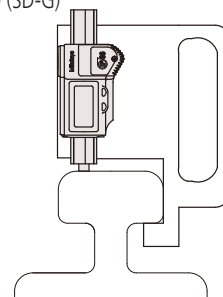

Detector head mechanism

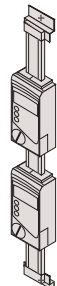

Mitutoyo's Digital Readout Packages

Mounting Hardware Included on all machine retrofit packages

All DRO Packages Include:

- > KA-200 Counter
- > KA-200 Counter tray/arm kit
- > Linear Scales
- > Bracket Kit(s)



SAVE
\$200
PER PACKAGE

MeasurLink ENABLED
Data Management Software by Mitutoyo

Package Part No.	Description	X Travel	Y Travel	Z Travel	X Axis Type	Y Axis Type	Z Axis Type	List	Promo
64PKA058A	12" X 30" DRO Mill Package	30"	12"		AT715	AT715		\$1,490.00	\$1,290.00
64PKA059A	12" X 36" DRO Mill Package	36"	12"		AT715	AT715		\$1,490.00	\$1,290.00
64PKA060A	14" X 30" DRO Mill Package	30"	14"		AT715	AT715		\$1,490.00	\$1,290.00
64PKA062A	16" X 36" DRO Mill Package	36"	16"		AT715	AT715		\$1,490.00	\$1,290.00
64PKA063A	16" X 40" DRO Mill Package	40"	16"		AT715	AT715		\$1,490.00	\$1,290.00
64PKA035A	6" X 28" Lathe Package	6"		28"	AT116		AT715	\$1,450.00	\$1,250.00
64PKA039A	8" X 40" Lathe Package	8"		40"	AT116		AT715	\$1,450.00	\$1,250.00
64PKA042A	10" X 40" Lathe Package	10"		40"	AT116		AT715	\$1,450.00	\$1,250.00
64PKA046A	12" X 40" Lathe Package	12"		40"	AT116		AT715	\$1,450.00	\$1,250.00
64PKA050A	12" X 60" Lathe Package	12"		60"	AT116		AT715	\$1,650.00	\$1,450.00
64PKA052A	14" X 40" Lathe Package	14"		40"	AT116		AT715	\$1,450.00	\$1,250.00
64PKA057A	16" X 60" Lathe Package	16"		60"	AT116		AT715	\$1,650.00	\$1,450.00
64PKA026A	6" X 12" Grinder Package	6"		12"	AT116		AT116	\$1,620.00	\$1,420.00
64PKA028A	8" X 12" Grinder Package	8"		12"	AT116		AT116	\$1,620.00	\$1,420.00
64PKA029A	8" X 14" Grinder Package	8"		14"	AT116		AT116	\$1,620.00	\$1,420.00

Trinocular Stereo Microscope MSM-414TL

- > Continuous 1X - 4X magnification
- > Image always in focus throughout zoom range
- > Crisp, erect images with high resolution and excellent stereoscopic effect
- > Stereo-tube can be rotated a full 360°, for viewing at any angle
- > Bilateral zoom control knob adds convenience and increases operator efficiency
- > Diopter adjustment for both eyepieces

Model	MSM-414TL
Order No.	377-974A
Optical tube	Trinocular
Total magnification	10X - 40X
Eyepiece	10X (377-016)
Objective	1X - 4X
Working distance	80mm
Field of view	20mm - 5mm
Dimensions	H=13.2" x W=6.7" x D=9.3"
Mass	13.2 lbs (6kg)



Order No.	Description	List	Promo
377-974A	MSM-414TL Stereo Microscope	\$1,380.00	\$1,311.00
377-481	C-mount Video Adapter for MSM-414TL	\$53.85	\$51.16
64AAB526	Moticam 1080, 2.0 Mega Pixels, HDMI/USB	\$1,250.00	\$1,187.50



Camera with software for digital viewing



September 10 - 15, 2018
McCormick Place | Chicago, IL
VISIT US AT BOOTH E-5214

www.mitutoyo.com

Ultra-High Accuracy

Laser Scan Micrometer LSM-902/6900

- > High-accuracy inspection of pin and plug gages and other tight-tolerance parts such as medical and aerospace.
- > Ultra-high accuracy: Linearity of $\pm 0.5\mu\text{m}$ for entire range.
- > Statistical calculation mode.
- > Ultra-high repeatability of $\pm 0.05\mu\text{m}$.
- > RS-232C output, I/O interface are standard.

MeasurLink⁺ ENABLED
Data Management Software by Mitutoyo



544-496A

Bench Top

Laser Scan Micrometer LSM-9506

- > Integrated display and measuring unit into one unit.
- > Statistical calculation mode.
- > RS-232C output, I/O interface, and SPC output interface are standard.

MeasurLink⁺ ENABLED
Data Management Software by Mitutoyo



544-116-1A

Order Number	Range	Resolution	List	Promo
544-496A	.004" - 1.0"/0.1mm - 25mm	.000001" - .0005"/0.00001 - 0.01mm	\$12,200.00	\$10,980.00
544-116-1A	.020" - 2.36"/0.5mm - 60mm	.000002" - .005"/0.00005 - 0.1mm	\$8,940.00	\$8,046.00

QUICKTOOL* is free downloadable software that makes programming the LSM-6200 quick and easy.
*For use with customer-supplied PC and optional RS-232C cable.



www.mitutoyo.com/LSM
VIDEO DEMO

High-Accuracy Non-Contact Measuring Systems

- > Excellent linearity: down to ± 0.3 micron.
- > High-speed scanning capable: 3,200 scans per second.
- > Various ranges available for selecting the best laser for your application.
- > Statistical calculation mode.
- > Memory function has been increased to allow storage of up to 100 programs.

QUICKTOOL* is free downloadable software that makes programming the LSM-6200 quick and easy.
*For use with customer-supplied PC and optional RS-232C cable.

Package



MeasurLink⁺ ENABLED
Data Management Software by Mitutoyo

LSM-6200 Display Unit Included

Order No	Model	Range Inch	Range mm	Repeatability	Linearity	Scanning Rate	List	Promo
64PKA117	LSM-500S	.0002" - .08"	0.005~2mm	$\pm 0.03\mu\text{m}$	$\pm 0.3\mu\text{m}$	3,200 scans/sec	\$10,370.00	\$7,090.00
64PKA118	LSM-501S	.002" - .4"	0.05~10mm	$\pm 0.04\mu\text{m}$	$\pm 0.5\mu\text{m}^\dagger$	3,200 scans/sec	\$9,330.00	\$6,050.00
64PKA119	LSM-503S	.012" - 1.18"	0.3~30mm	$\pm 0.11\mu\text{m}$	$\pm 1.0\mu\text{m}^\dagger$	3,200 scans/sec	\$10,110.00	\$6,830.00
64PKA120	LSM-506S	.04" - 2.36"	1~60mm	$\pm 0.36\mu\text{m}$	$\pm 3\mu\text{m}^\dagger$	3,200 scans/sec	\$11,480.00	\$8,200.00
64PKA121	LSM-512S	.04" - 4.72"	1~120mm	$\pm 0.85\mu\text{m}$	$\pm 6\mu\text{m}^\dagger$	3,200 scans/sec	\$17,680.00	\$14,400.00
64PKA122	LSM-516S	.04" - 6.30"	1~160mm	$\pm 1.4\mu\text{m}$	$\pm 7\mu\text{m}^\dagger$	3,200 scans/sec	\$28,480.00	\$25,200.00

[†] Linearity over entire range. Higher accuracies are possible over smaller ranges.

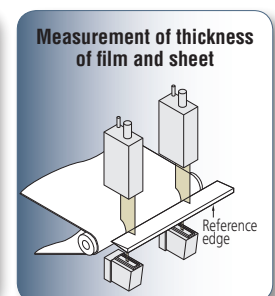
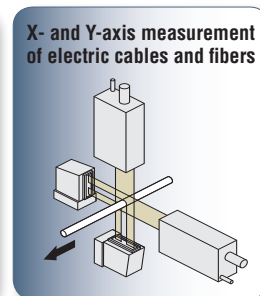
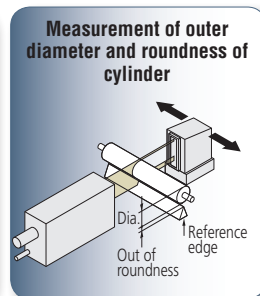
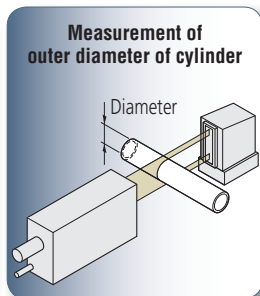
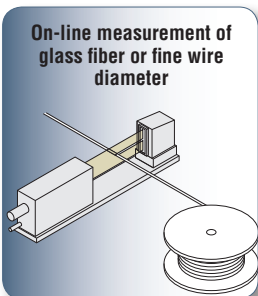

Prices effective April 2 through June 29, 2018

Complimentary Shipping on ALL Profile Projectors*

DOMESTIC U.S. ORDERS ONLY



*Complimentary ground shipping for the 48 contiguous United States. Offer applies to orders placed April 2 through June 29, 2018. Mitutoyo America Corporation reserves the right to change or discontinue this offer at any time. This offer is void wherever prohibited or restricted by law. No cash value. For Alaska and Hawaii special rates apply. Contact us for details.

Complimentary shipping cannot be applied toward previously placed orders. Orders may only be shipped to a single address. If customer returns product, they are responsible for the shipping cost. Refer to our terms and conditions for further details.

PV-5110 Profile Projector

- > Large 500mm screen
- > Floor model uses a downward illumination system.
- > Digital readout protractor screen (including zero-setting, ABS/INC coordinate switching functions) for easy and error-free angle measurement.
- > Angled screen allows projected images to be easily traced or compared with a template.
- > The oblique surface illumination system provides clear and bright images, allowing easy inspection of non-reflective workpieces such as plastic parts or printed materials.



PV-5110



MeasurLink ENABLED
Data Management Software by Mitutoyo

Standard Accessories

- > 200 x 100mm (8 x 4") XY travel
- > 10x projection lens set
- > Surface illumination unit
- > Counter stand for KA counter
- > Power cord, halogen bulb, fuse, grounding wire, allen wrench, vinyl cover

Order No.	Description	List
304-919A	Profile Projector PV-5110	\$24,200.00
264-156A	QM-Data200 (Arm-Mount Model)	\$2,720.00
332-151	Optoeye-200	\$1,650.00
12AAE672	Attachment (B) for Optoeye-200	\$58.65
174-183A	KA 200 Counter	\$587.00

PJ-A3000 Vertical Profile Projector

- > A series of midsize profile projectors featuring bright, 12.40" (315mm) diameter screens and easy-to-operate XY measurement tables.
- > A floating table makes measuring quick and easy.
- > Built-in, easy-to-read digital counters are located near the projection screen, thereby minimizing strain associated with excessive movement.
- > For edge-sensing capabilities, order the Optoeye-200, part number 332-151.



PJ-A3010F-200

MeasurLink ENABLED
Data Management Software by Mitutoyo

Order No.	Description	XY Travel	List
302-701A	PJ-A3010F-200	8" x 4"	\$13,600.00
302-702A	PJ-A3005F-150	6" x 2"	\$12,000.00
302-703A	PJ-A3010F-100	4" x 4"	\$10,800.00
302-704A	PJ-A3005D-50	2" x 2"	\$8,890.00

PH-A14 Horizontal Profile Projector

- > Mitutoyo's lens technology and workmanship combine to provide a bright, crisp image for error-free inspection.
- > 8" x 4" floating-type workstage incorporates linear scales for fast, accurate measurement.
- > The workstage provides high accuracy and can handle a workload of up to 100 lbs.
- > 10x objective lens and fiber illuminator are standard accessories.



MAC No.	Description	List
64PKA086A	PH-A14 w/KA-200 Counter & Tray	\$7,490.00
64PKA087	PH-A14 w/QM Data (Arm Mount)	\$9,490.00

Optional Accessories

Order No.	Description	List
264-156A	QM-Data 200 (Arm-Mount Model)	\$2,720.00
332-151	Optoeye 200	\$1,650.00
64PMI167	Stand for PJ-A3000	\$688.00
12AAA807	RS-232C Cable	\$54.30
12AAE671	Attachment board (A) for Optoeye-200	\$40.80



QM Data
2-D Data
Processing Unit



Optoeye-200
Edge detection system



KA 200 Counter



Mitutoyo America Corporation

965 Corporate Boulevard
Aurora, Illinois 60502
1-888-648-8869

SPRING PROMO 2018

PRECISION TOOLS & INSTRUMENTS

Mitutoyo products are sold only through authorized distributors. To find an authorized Mitutoyo distributor near you, visit: www.mitutoyo.com/distributor-locator/



September 10 – 15, 2018
McCormick Place | Chicago, IL
VISIT US AT BOOTH E-5214

2018 Tradeshow Schedule:

- Smart Manufacturing Experience 2018 Booth - #415 - Apr 30, 2018 - Boston, MA
- OTC 2018 - Booth #8553 - Apr 30, 2018 - Houston, TX
- NPE 2018 - Booth #S19131 - May 7, 2018 - Orlando, FL
- NCSL International Conference - Booth #805 - Aug 27, 2018 - Portland, OR
- IMTS 2018 - Booth #E-5214 - Sep 10, 2018 - Chicago, IL
- Neuroscience 2018 - Booth #905 - Nov 3, 2018 - San Diego, CA

Note: All information regarding our products, and in particular the illustrations, drawings, dimensional and performance data contained in this printed matter as well as other technical data are to be regarded as approximate average values. We therefore reserve the right to make changes to the corresponding designs. The stated standards, similar technical regulations, descriptions and illustrations of the products were valid at the time of printing. In addition, the latest applicable version of our General Trading Conditions will apply. Only quotations submitted by ourselves may be regarded as definitive. Specifications are subject to change without notice.

Mitutoyo products are subject to US Export Administration Regulations (EAR). Re-export or relocation of our products may require prior approval by an appropriate governing authority.

Trademarks and Registrations

Designations used by companies to distinguish their products are often claimed as trademarks. In all instances where Mitutoyo America Corporation is aware of a claim, the product names appear in initial capital or all capital letters. The appropriate companies should be contacted for more complete trademark and registration information.

We reserve the right to change specifications and prices without notice. Not valid with any other offer or promotion, previous purchases. Please refer to terms and conditions for additional information. Domestic U.S. orders only.

© 2018 Mitutoyo America Corporation

50M 0318-05 • Printed in USA • Mar. 2018



SPRING PROMO 2018

PRECISION TOOLS & INSTRUMENTS

Effective April 2 through June 29, 2018

SPRING PROMO 2018

MeasurLink[®] ENABLED

Data Management Software by Mitutoyo

