

Fowler[®]
HIGH PRECISION

TOOL-A-THON[®]

Vol. 18.2

Valid May 1st - Aug. 31st



Visit us at  **IMTS2018** Booth No. 135616
September 10th - 15th



**Enter For A
Chance To**
See details inside!

WIN!

www.fowlerprecision.com



Fowler-Bowers **BLUETOOTH** XTH3 HOLEMATIC Pistol Grip Sets



TABLET!

with Complete Set Purchase!

Watch the Demo!



"Fowler-Bowers makes an awesome product!"
T.T.



54-567-050-BT

- Self centering 3 point heads above 0.250"
- USB connectivity and Bluetooth
- Resolution: 0.00005"/0.001mm
- IP67 rated
- To reduce hand fatigue, the travel of the HOLEMATIC trigger is adjustable for minimum over travel
- Tungsten carbide measuring faces on all 3-point heads from 0.5" (12.5mm) and up
- Sizes over 0.500" (12.5mm) feature blind bore capability
- Includes UKAS certificates for all pistol grip, heads and rings

Contact the Fowler Technical Department for special measuring applications

Order No.	Range	Includes	List Price	Sale Price
54-567-009-BT	0.080" - 0.250"/2 - 6mm (2-point heads)	5 heads, 1 handle, 3 rings	\$6137.32	\$5090.00
54-567-010-BT	0.250" - 0.375"/6 - 10mm	2 heads, 1 handle, 1 ring	2406.45	1995.00
54-567-020-BT	0.375" - 0.750"/10 - 20mm	3 heads, 1 handle, 2 rings	2815.32	2335.00
54-567-050-BT	0.750" - 2" /20 - 50mm	3 heads, 1 handle, 2 rings	3635.16	3015.00
54-567-100-BT	2 - 4"/50 - 100mm	3 heads, 1 handle, 2 rings	4046.12	3355.00
54-567-105-BT	4 - 6"/100 - 150mm	2 heads, 1 handle, 1 ring	3635.16	3015.00
54-567-110-BT	6 - 8" /150 - 200mm	2 heads, 1 handle, 1 ring	4798.32	3980.00
54-567-200-BT	4 - 8" /100 - 200mm	4 heads, 1 handle, 2 rings	7594.92	6300.00
54-567-210-BT	0.750" - 4" /20 - 100mm	6 heads, 1 handle, 4 rings	5915.71	4900.00
54-567-620-BT	0.250" - 0.750" /6 - 20mm	5 heads, 1 handle, 3 rings	3355.29	2780.00
Connectivity Cables/Accessory				
54-115-526-0	Proximity cable with USB connection		\$138.79	\$125.00
54-115-527-0	Proximity cable with serial connection		138.79	125.00
54-115-246-BT	USB bluetooth receiver		49.25	44.00



Fowler-Bowers **BLUETOOTH** XTD3 Electronic Holemike Sets



FREE TABLET!

with Complete Set Purchase!



54-367-110-BT

- Self centering 3 point heads above 0.250"
- USB connectivity and Bluetooth
- Resolution: 0.00005"/0.001mm
- IP67 rated
- Ratchet stop for consistent measurement
- Sizes over 1"/25mm offer extended travel
- Includes UKAS certificates for micrometer, heads and settings rings



Contact the Fowler Technical Department for special measuring applications

Order No.	Range	Includes	List Price	Sale Price
54-367-000-BT	0.080" - 0.250"/2 - 6mm (2-point heads)	5 heads, 1 handle, 3 rings	\$5593.19	\$4640.00
54-367-010-BT	0.250" - 0.375"/6 - 10mm	2 heads, 1 handle, 1 ring	2330.50	1930.00
54-367-020-BT	0.375" - 0.750"/10 - 20mm	3 heads, 1 handle, 2 rings	2780.99	2300.00
54-367-050-BT	0.750" - 2" /20 - 50mm	3 heads, 1 handle, 2 rings	3776.65	3130.00
54-367-100-BT	2 - 4"/50 - 100mm	3 heads, 1 handle, 2 rings	4181.37	3465.00
54-367-105-BT	4 - 6"/100 - 150mm	2 heads, 1 handle, 1 ring	3530.08	2925.00
54-367-110-BT	6 - 8" /150 - 200mm	2 heads, 1 handle, 1 ring	4663.07	3865.00
54-367-200-BT	4 - 8" /100 - 200mm	4 heads, 1 handle, 2 rings	7368.11	6110.00
Connectivity Cables/Accessory				
54-115-526-0	Proximity cable with USB connection		\$138.79	\$125.00
54-115-527-0	Proximity cable with serial connection		138.79	125.00
54-115-246-BT	USB bluetooth receiver		49.25	44.00

Prices & Specifications are subject to change without notice.



Find us on social media!

Fowler-Bowers Universal Gage Set

Internal & External Measurements up to 118"



- Internal and external measurement
- Extremely large measuring range 0 - 118"/0 - 3000mm
- Large range of accessories with constant measuring pressure and digital readout
- Stackable extensions for increasing range
- Anvil travel of 0.590"/15mm

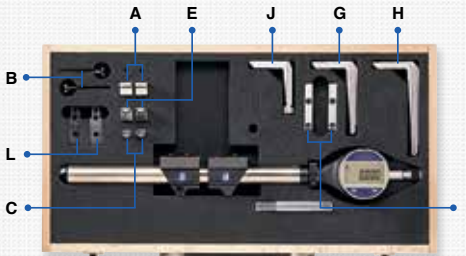

54-265-777-0

Accessories

A.	54-265-045-0	Pair of Flat Shoulder Anvils
B.	54-265-048-0	Pair of Internal Disc Anvils (large)
C.	54-265-049-0	Pair of Internal/External Disc Anvils (small)
D.	54-265-055-0	Pair of Clamping adaptors
E.	54-265-047-0	Pair of Cylindrical Shoulder Anvils
F.	54-265-015-0	Pair of Spherical Tip Contact Points
G.	54-265-030-0	Pair of Measuring Arms 3"/75mm long
H.	54-265-040-0	Pair of Measuring Arms 4"/100mm long
I.	54-265-043-0	Pair of Depth Stops
J.	54-265-020-0	Pair of Measuring Arms 2"/50mm long
K.	54-265-010-0	Pair of Flat Contact Points
L.	54-265-041-0	Pair of Mounting attachments

Available on special order

Pair of ball inserts for gear/spline measurements. Thread inserts for internal/external threads. Special anvils such as cones, balls, pins, etc. Contact our Technical Department for price quotes.

Order No.	Description	List Price	Sale Price
54-265-777-0	Universal Gage Set with digital readout and accessories listed above Internal Range 1.18 - 10"/30 - 250mm External Range 0 - 8.4"/0 - 215mm	\$7165.50	\$6450.00
Accessories			
54-265-000-0	Universal Gage Only with Indicator	\$3600.00	\$3100.00
54-265-001-0	Universal Gage Only No Indicator	2770.20	2300.00
54-265-090-0	6" extension: Increases range of universal gage by 6"/150mm	316.20	260.00
54-265-100-0	20" extension: Increases range of universal gage by 20"/500mm	969.00	800.00
54-265-010-0	Pair of Flat Contact Points	109.34	90.00
54-265-015-0	Pair of Spherical Tip Contact Points	109.34	90.00
54-265-020-0	Pair of Measuring Arms 2"/50mm long	522.90	434.00
54-265-030-0	Pair of Measuring Arms 3"/75mm long	542.25	450.00
54-265-040-0	Pair of Measuring Arms 4"/100mm long	633.29	525.00
54-265-041-0	Pair of Mounting attachments	590.43	490.00
54-265-043-0	Pair of Depth Stops	365.38	300.00
54-265-045-0	Pair of Flat Shoulder Anvils	468.28	385.00
54-265-047-0	Pair of Cylindrical Shoulder Anvils	468.28	385.00
54-265-048-0	Pair of Internal Disc Anvils (large)	291.52	240.00
54-265-049-0	Pair of Internal/External Disc Anvils (small)	291.52	240.00
54-265-055-0	Pair of Clamping adaptors	57.84	45.00

Fowler-Bowers XT-Series Holemikes



SPECIAL DEAL!



FREE

Free 6" IP54 Electronic Caliper with Holemike purchase! \$142.00 Value

The Fowler-Bowers range of mechanical two and three point bore micrometers are now available as XT extended travel holemikes, allowing a wide measurement range without the need to interchange anvils.



- 3-pt contact with tungsten carbide measuring anvils above 0.5"
- Blind bore measuring heads featured above 0.5"
- Ratchet stop for consistent measuring
- Extensions available for deep measuring
- Includes UKAS certificates for all Holemikes and setting rings

Order No.	Range	Grads.	Accuracy	Meas. Depth	Ring Included	List Price	Sale Price
52-255-310-0	0.250" - 0.312"	0.00025"	0.00015"	2.28"	0.312"	\$723.39	\$560.00
52-255-311-0	0.312" - 0.375"	0.00025"	0.00015"	2.28"	0.312"	669.81	520.00
52-255-312-0	0.375" - 0.500"	0.00025"	0.00015"	2.28"	0.5"	669.81	520.00
52-255-313-0	0.500" - 0.625"	0.00025"	0.00015"	2.44"	0.5"	669.81	520.00
52-255-314-0	0.625" - 0.750"	0.00025"	0.00015"	2.44"	0.75"	686.87	530.00
52-255-315-0	0.750" - 1"	0.00025"	0.00015"	2.60"	0.75"	754.39	585.00
52-255-316-0	1" - 1.375"	0.00025"	0.00015"	2.60"	1.375"	1074.84	835.00
52-255-317-0	1.375" - 2"	0.00025"	0.00015"	3.15"	1.375"	1100.54	855.00
52-255-318-0	2" - 2.625"	0.00025"	0.0002"	3.15"	2.625"	1312.78	1020.00
52-255-319-0	2.625" - 3.250"	0.00025"	0.0002"	3.15"	2.625"	1324.53	1030.00
52-255-320-0	3.250" - 4"	0.00025"	0.0002"	3.94"	3.25"	1652.47	1285.00

Fowler-Bowers XT-Series Holemike Sets

Order No.	Range	Includes	List Price	Sale Price
52-255-565-0	0.250" - 0.375"	2 heads, 2 handles, 1 ring	\$1606.38	\$1250.00
52-255-665-0	0.375" - 0.750"	3 heads, 3 handles, 2 rings	1829.23	1420.00
52-255-775-0	0.750" - 2"	3 heads, 3 handles, 2 rings	2874.11	2240.00
52-255-885-0	2" - 4"	3 heads, 3 handles, 2 rings	3896.40	3200.00

Still Using Pin Gages?

MicroGage

2-Point Small Bore Gaging System



The Fowler-Bowers MicroGage 2-point bore gaging system has been designed specifically for the measurement of small bores between 1.0 - 6.0 mm. The measuring heads are equipped with spherical, split-ball, hard-chromed contact points.

- System range : 0.040" - 0.250"/1 - 6mm
- Switchable resolution 0.0005", 0.0005"/0.01, 0.001, 0.0005mm
- Repeatability : 0.00005"/0.001mm
- Sets include setting rings
- UKAS-certificates as standard with all setting rings
- Depth stops available

Order No.	Description	List Price	Sale Price
54-551-010-0	0.037" - 0.096"/0.95 - 2.45mm	\$3184.87	\$2950.00
54-551-011-0	0.060" - 0.167"/1.5 - 4.25mm	3117.04	2850.00
54-551-012-0	0.089" - 0.250"/2.25 - 6.35mm	3286.21	3010.00
Connectivity Cables			
54-115-526-0	Proximity cable with USB connection	\$138.79	125.00
54-115-527-0	Proximity cable with serial connection	138.79	125.00

Prices & Specifications are subject to change without notice.

Fowler

TOOL-A-THON Vol. 18.2



Find us on social media!

f

e

in

YouTube



Bluetooth Ultra-Cal VI Electronic Calipers



54-100-167-0



Learn more at



NOW
available with
ISO Cert.

- IP67 rated
- Available with or without Bluetooth
- Heavy duty frame
- Extra large display



Order No.	Description	Accuracy	Resolution	List Price	Sale Price
Bluetooth					
54-100-167-0	6"/150mm	0.0008"/20µm	0.0005"/0.01mm	\$337.61	\$295.00
54-100-167-C	NEW 6"/150mm with ISO/A2LA Certification				\$324.00
54-100-168-0	8"/200mm	0.0012"/30µm	0.0005"/0.01mm	626.94	495.00
54-100-169-0	12"/300mm	0.0012"/30µm	0.0005"/0.01mm	835.36	650.00
Without Data Output					
54-100-177-0	6"/150mm	0.0008"/20µm	0.0005"/0.01mm	\$117.30	\$105.00
54-100-178-0	8"/200mm	0.0012"/30µm	0.0005"/0.01mm	239.70	215.00
54-100-179-0	12"/300mm	0.0012"/30µm	0.0005"/0.01mm	321.30	295.00
Accessory					
54-115-246-BT	USB bluetooth receiver			\$49.25	\$44.00

Ultra-Cal VI Proximity Electronic Calipers

NEW!



54-100-444-1



- IP67 rated
- Uses proximity cables for SPC data
- Heavy duty frame
- Extra large display

Order No.	Description	Accuracy	Resolution	List Price	Sale Price
54-100-444-1	6"/150mm	0.0008"/20µm	0.0005"/0.01mm	\$158.10	\$140.00
54-100-448-1	8"/200mm	0.0012"/30µm	0.0005"/0.01mm	285.60	250.00
54-100-412-1	12"/300mm	0.0012"/30µm	0.0005"/0.01mm	382.50	350.00
Connectivity Cables					
54-115-526-0	Proximity cable with USB connection			\$138.79	\$125.00
54-115-527-0	Proximity cable with serial connection			138.79	125.00

Ultra-Cal V Electronic Calipers

Buy 5, Get 1 FREE!



54-100-067-1

NOW
available with
ISO Cert.

LIFETIME WARRANTY ✓



IP67

Fowler
PROXIMITY INTERFACE

- 4-way measurement, inside, outside, depth and step (6" & 8" models)
- Hardened stainless steel construction
- Direct RS-232 output
- Features Absolute/Relative Measuring Modes
- Thumbroll (6" and 8" models only)

Order No.	Description	Accuracy	Resolution	List Price	Sale Price
54-100-667-0	Buy 5 standard 6"/150mm Electronic Calipers (54-100-067-1), Get 1 FREE			\$1012.80	\$800.00
54-100-067-1	6"/150mm	0.0008"/20µm	0.0005"/0.01mm	\$202.56	\$160.00
54-100-067-C	NEW 6"/150mm with ISO/A2LA Certification				189.00
54-100-068-1	8"/200mm	0.0012"/30µm	0.0005"/0.01mm	482.23	365.00
54-100-069-1	12"/300mm	0.0012"/30µm	0.0005"/0.01mm	578.67	475.00
Connectivity Cables					
54-115-526-0	Proximity cable with USB connection			\$138.79	\$125.00
54-115-527-0	Proximity cable with serial connection			138.79	125.00

Micron 0.00005" Electronic Caliper

Absolute Reading!



- Bluetooth connectivity
- High resolution: 0.00005"/0.001mm
- Accuracy up to 4": 0.0006"/0.015mm
- Accuracy above 4": 0.0012"/0.03mm
- Repeatability: 0.00016"/0.004mm
- Heavy duty frame (3.5mm)

LIFETIME WARRANTY ✓



IP67



Order No.	Description	List Price	Sale Price
54-100-100-0	6"/150mm Micron Electronic Caliper	\$392.23	\$320.00
Accessory			
54-115-246-BT	USB bluetooth receiver	\$49.25	\$44.00

Prices & Specifications are subject to change without notice.

7

Fowler

TOOL-A-THON® Vol. 18.2



Find us on social media!

4" thru 12" Economy Digital Calipers

Absolute Reading!



54-100-000-2

- Absolute sensor technology
- Stainless steel frame
- 4-way measuring
- Resolution: 0.0005"/0.01mm

Order No.	Range	Accuracy	List Price	Sale Price
54-100-004-2	0 - 4"/100mm Caliper	0.001"/0.02mm	\$108.94	\$70.00
54-100-000-2	0 - 6"/150mm Caliper	0.001"/0.02mm	127.03	\$2.00
54-100-008-2	0 - 8"/200mm Caliper	0.0015"/0.04mm	149.17	\$110.00
54-100-112-2	0 - 12"/300mm Caliper	0.0015"/0.04mm	194.47	\$125.00
Accessory				
54-115-100-0	Wireless Transmitter		\$108.59	\$94.00

Water Resistant IP54 Electronic Calipers

Absolute Reading!



54-100-777-2



- Absolute sensor technology
- 4-way measuring
- Stainless steel frame
- Resolution: 0.0005"/0.01mm

Order No.	Range	Accuracy	List Price	Sale Price
54-100-777-2	0 - 6"/150mm	0.001"/0.02mm	\$142.65	\$90.00
54-100-712-2	0 - 12"/300mm	0.0015"/0.04mm	207.52	\$120.00
Accessory				
54-115-100-0	Wireless Transmitter		\$108.59	\$94.00

EURO-CAL IV® Electronic Calipers



54-100-330-1

- Absolute/Incremental Measurement
- Resolution: 0.0005"/0.01mm (Fractions in 1/64" increments)
- Stainless steel frame
- 4-way measuring

Order No.	Range	Accuracy	List Price	Sale Price
54-100-330-1	6"/150mm	± 0.001"/0.02mm	\$129.62	\$95.00
54-100-331-0	8"/200mm	± 0.001"/0.02mm	153.45	\$115.00
54-100-332-0	12"/300mm	± 0.0015"/0.03mm	196.84	\$150.00

XTRA-VALUE CAL Electronic Calipers

NEW! Buy a 12" Get a 6" **FREE**

Buy a 12" (54-101-300-1) at list price and get a 6" (54-101-150-2) FREE



54-101-300-1

"Fair price,
good quality, prompt
processing"

Terri F.

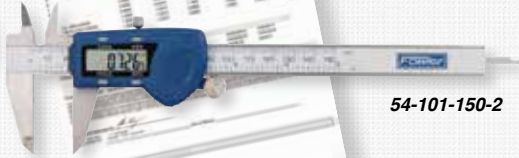

54-101-150-2

- Accuracy: 0.001"/0.02mm (6" models)
- Stainless steel frame
- Large easy-to-read display
- Resolution: 0.0005"/0.01mm
- Absolute/Incremental Measurement
- 4-way measuring



Order No.	Range	Display Type	List Price	Sale Price
54-101-300-P	NEW Buy a 12" (54-101-300-1) and Get a 6" (54-101-150-2) FREE		\$149.07	\$99.34
54-101-150-2	6"/150mm	Regular Display - includes FREE NIST Cert.	49.73	39.00
54-101-600-1	6"/150mm	Super Large Display with hold feature	64.86	50.00
54-101-200-1	8"/200mm	Regular Display	77.80	64.00
54-101-800-1	8"/200mm	Super Large Display with hold feature	97.24	75.00
54-101-300-1	12"/300mm	Regular Display - includes FREE NIST Cert.	99.34	82.00
54-101-900-1	12"/300mm	Super Large Display with hold feature	129.84	110.00

Poly-Cal[®] Electronic Caliper

Absolute Reading!



- Range 6"/150mm
- Resolution 0.0005"/0.01mm (Fractions by 1/64" increments)
- Absolute/Incremental Measurement
- Direct inch/metric/fraction conversion
- Accuracy +/- 0.008"
- Supplied with clip-on vinyl pouch

Polycarbonate Caliper Includes

- Fractional Measurement
- Easy-To-Read Display
- Lightweight frame

INCH • METRIC • FRACTION[™]

Order No. 54-101-175-0

Sale \$22.00

List \$28.44

Prices & Specifications are subject to change without notice.



0 - 6" Dial Caliper



- 4-way measuring
- Covered rack
- Accuracy $\pm 0.001"$
- 0.100" per revolution
- Dial graduation: 0.001"
- Hardened stainless steel rack

Order No. 52-008-005-0

Sale \$59.00

List \$85.00

Machinist Grade Dial Calipers



52-008-706-0



52-008-707-0



52-008-709-0

- 4-way measuring
- Solid stainless steel construction
- 0.100"/2mm range per revolution
- 0.001"/0.02mm reading dial face
- Tough shockproof gearing

"Very precise with consistent readings. I would never change this analog for a digital one"
Erick T.

Order No.	Range	Dial Face Color	Accuracy	List Price	Sale Price
52-008-706-0	0 - 6"	White	$\pm 0.001"$	\$80.00	\$60.00
52-008-707-0	0 - 6"	Black	$\pm 0.001"$	80.00	60.00
52-008-708-0	0 - 8"	White	$\pm 0.0015"$	97.62	78.00
52-008-709-0	0 - 150mm (Metric Model)	Yellow	$\pm 0.02\text{mm}$	80.00	60.00

Inch/Metric Reading Dial Caliper

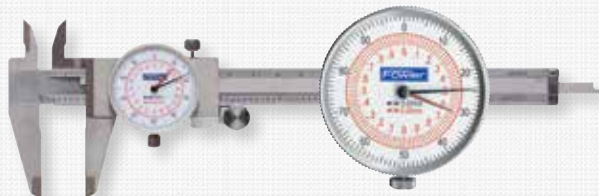

- Range: 0 - 8"/0 - 200mm
- Accuracy: 0.0015"/0.04mm
- Graduation: 0.001"/0.02mm
- Dial face reads in both inch (black) and metric (red)
- Hardened stainless steel throughout

- Inside, outside, step and depth measurement
- Raised sliding surface prevents wear and defacement of graduations
- Covered stainless steel rack
- 6" and 12" models also available

Order No. 52-030-008-0

Sale \$89.00

List \$122.38

XTRA-RANGE[®] Electronic Calipers



54-100-312-0



NEW SPC Cable Available!



Shop-Hardened Case!

- Hold feature
- Absolute/Incremental measurement
- Preset mode includes offset size for ID measurements
- All sizes feature fine adjustment screw
- Resolution: 0.0005"/0.01mm

Order No.	Range	Jaw Depth	Accuracy	List Price	Sale Price
54-100-312-0	0 - 12"/300mm	3.5"	0.002"/0.04mm	\$224.38	\$164.00
54-100-024-1	0 - 24"/600mm	4"	0.003"/0.08mm	326.79	270.00
54-100-042-1	0 - 40"/1000mm	4.9"	0.004"/10mm	1095.00	780.00
<i>Accessory</i>					
54-115-781-0	NEW Xtra-Range SPC cable			\$98.25	\$85.00

Extended Range Dial Calipers

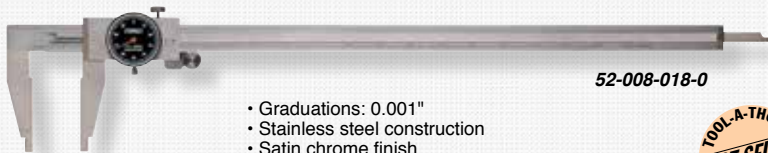

52-008-018-0

- Graduations: 0.001"
- Stainless steel construction
- Satin chrome finish
- Depth rod
- 0.500" internal measuring nibs



Order No.	Range	Depth of Jaws	List Price	Sale Price
52-008-018-0	18" Caliper	3.125"	\$257.08	\$155.00
52-008-024-0	24" Caliper	3.375"	311.52	235.00

0 - 8" Heavy Duty Dial Caliper with Cross Jaws



- Graduations: 0.001"
- Large 0.100" one-rev dial
- Jaw length 2.5"
- Depth rod
- 4-way measurement
- Cross-jaws for direct internal measurement
- Stainless steel, satin chrome finish

Order No. 52-025-108-0

Sale \$119.00

List \$148.49

Prices & Specifications are subject to change without notice.



Rapid-Mic Quick-Displacement Electronic Micrometers



54-815-030-0

**WORLD'S FINEST
Micrometer!**

NOW
available with
ISO Cert.

“ I have been in the machining business for over 30 years and is by far the best mic I have ever had. One little thing or should I rephrase that, one huge thing. This mic comes with a lifetime warranty... no other company can provide that! ”
John T.

- Position recall
- Delrin quick displacement thimble
- Adjustable measuring force, 5N/10N (54-815-030-0 only)
- Menu customizable with free software
- Non-rotating spindle, 10mm/spindle rotation
- USB output or bluetooth available



54-815-111-0

LIFETIME WARRANTY



Watch the Demo!



NEW Bluetooth Ranges NOW Available!

Order No.	Description	Max Error	List Price	Sale Price
54-815-030-0	0 - 1.18"/0 - 30mm	0.00012"/0.003mm	\$525.09	\$435.00
54-815-030-C	NEW 1.18"/30mm with ISO/A2LA Certification			460.00
54-815-060-0	1.18" - 2.6"/30 - 66mm	0.00016"/0.004mm	776.97	710.00
54-815-100-0	2.6" - 4.0"/66 - 102mm	0.00020"/0.005mm	1086.60	960.00
Set				
54-815-111-0	0 - 4"/0 - 102mm		\$2369.46	\$1995.00
Bluetooth Models				
54-815-130-0	0 - 1.18"/0 - 30mm	0.00012"/0.003mm	\$776.97	\$669.00
54-815-160-0	NEW 1.18" - 2.6"/30 - 66mm	0.00016"/0.004mm	1028.16	955.00
54-815-110-0	NEW 2.6" - 4.0"/66 - 102mm	0.00020"/0.005mm	1338.24	1199.00
Bluetooth Set				
54-815-112-0	NEW 0 - 4"/0 - 102mm		\$2938.62	\$2499.00
Connectivity Cables/Accessory				
54-115-526-0	Proximity cable with USB connection		\$138.79	\$125.00
54-115-527-0	Proximity cable with serial connection		138.79	125.00
54-115-246-BT	USB Bluetooth receiver		49.25	44.00

Anvil Kit and Ball Attachment



52-249-007-0
(Micrometer not included)



Anvil Kit Features:

- Fowler's Multi-Mic Anvil Kit contains six anvils and a ball attachment
- Popular accessories used with outside micrometers
- Fits micrometers with spindle diameters of 0.235", 0.250", 0.256" and 0.270"
- Each anvil is 0.500" long and is held on with its own reinforced neoprene boot.
- Anvils are hardened and ground alloy steel with a lapped measuring surface
- Made in the U.S.A. to exacting standards



52-249-007-0
(Micrometer not included)

Ball Attachment Features:

- Ball Attachment used on spindles or anvils. Allows for single point inside contact and measurements of cylindrical wall thicknesses.
- Fits micrometers with spindle diameters of 0.235", 0.250", 0.256" and 0.270"
- Reinforced rubber boot provides extra holding power.
- Used with outside micrometers.
- Hardened chrome alloy steel.
- Ball: diameter .200"; accuracy 0.000025"
- Includes 2 balls, 1 boot and case.

Order No.	Description	List Price	Sale Price
52-249-007-0	Micrometer Anvil Kit with 6 anvils and 1 ball attachment	\$69.26	\$55.00
52-285-000-0	0.200" Dia. Ball Attachment with spare ball	6.23	5.00

Micrometer Checking Set

Fowler's setting master is quick, easy and extremely accurate. It comes with a certificate of calibration and a fitted aluminum case. Save time and money by calibrating your own measuring tools quickly and easily.

Set Includes:

- Stand height: 12.5"
- 9 pc. Grade AS-0 gage block set (sizes: 0.625", 0.100", 0.125", 0.200", 0.250", 0.300", 0.500", 1.000" & 2.000"
- Certificate of calibration is traceable to NIST standards & provides the individual deviation of each block
- Optical flat (flatness: .000004" ; Parallelism: 0.00002")
- 4.0mm ball end T-handle hex wrench



Order No.	Description	List Price	Sale Price
53-813-001-2	Complete Checking Set	\$341.17	\$245.00
53-813-002-0	Mic Checker <i>without</i> Blocks	170.98	125.00



Find us on social media!

YouTube
LinkedIn
Twitter
Facebook



XTRA-VALUE II Electronic Micrometers



54-870-001-0

NEW SPC Cable Available!



- Resolution: 0.00005"/0.001mm
- Accuracy: ± 0.00016 "/0.004mm (up to 2")
- Carbide measuring faces
- Absolute and incremental modes
- Ratchet thimble

Order No.	Range	List Price	Sale Price
54-870-001-0	0 - 1"/0 - 25mm	\$97.24	\$72.00
54-870-002-0	1 - 2"/25 - 50mm	105.00	79.00
54-870-003-0	2 - 3"/50 - 75mm	119.00	88.00
54-870-004-0	3 - 4"/75 - 100mm	133.00	99.00
54-870-103-0	0 - 3"/0 - 75mm Set	286.54	210.00
<i>Accessory</i>			
54-115-779-0	NEW SPC Cable	\$133.55	\$99.00

Electronic Coolant Resistant Micrometers



54-860-001-1

NEW SPC Cable Available!



- Protected to IP54 specifications
- Automatic switch off
- Accuracy: ± 0.00016 "/0.004mm (up to 2")
- Resolution: 0.00005"/0.001mm
- Carbide measuring faces
- Absolute & incremental modes

Order No.	Range	List Price	Sale Price
54-860-001-1	0 - 1"/0 - 25mm	\$123.21	\$95.00
54-860-002-1	1 - 2"/25 - 50mm	142.65	109.00
54-860-003-1	2 - 3"/50 - 75mm	155.58	119.00
54-860-004-1	3 - 4"/75 - 100mm	180.56	137.00
54-860-103-1	0 - 3"/0 - 75mm Set	405.26	305.00
<i>Accessory</i>			
54-115-779-0	NEW SPC Cable	\$133.55	\$99.00

Fowler TOOL-A-THON® Vol. 18.2

Outside Inch Micrometers



52-240-101-1

**Save
over 20%
on SETS!**

Fowler micrometers are of the finest quality available, at prices that defy competition. Special care in design and workmanship create a long lasting precision tool.

- Hammertone blue baked enamel finish
- Microfine graduations on satin chrome finish and carbide tipped measuring faces
- Diameter of measuring faces: 0.256"
- Flatness: 0.00003"
- Quick, easy zero adjustment on sleeve
- Positive lever locking clamp
- Ratchet thimble
- Spindle thread hardened, ground and lapped for ultimate accuracy
- Anvil & spindle hardened and precision ground with microlap finish on tips
- Includes a wrench and case

Order No.	Range	Accuracy	List Price	Sale Price
52-240-101-1	0 - 1"	± 0.00015"	\$41.60	\$33.00
52-240-102-1	1 - 2" w/standard	± 0.00015"	48.36	38.00
52-240-003-1	2 - 3" w/standard	± 0.0002"	56.52	45.00
52-240-004-1	3 - 4" w/standard	± 0.0002"	63.15	50.00
52-240-005-1	4 - 5" w/standard	± 0.00025"	69.91	55.00
52-240-006-1	5 - 6" w/standard	± 0.00025"	76.67	61.00
52-240-007-1	6 - 7" w/standard	± 0.0003"	83.31	66.00
52-240-008-1	7 - 8" w/standard	± 0.0003"	98.11	78.00
52-240-009-1	8 - 9" w/standard	± 0.0003"	111.51	89.00
52-240-010-1	9 - 10" w/standard	± 0.0003"	126.43	101.00
52-240-011-1	10 - 11" w/standard	± 0.00035"	139.83	111.00
52-240-012-1	11 - 12" w/standard	± 0.00035"	153.23	122.00
Sets				
52-215-003-1	0 - 3" w/standards		\$180.03	\$130.00
52-215-004-1	0 - 4" w/standards		231.18	170.00
52-215-006-1	0 - 6" w/standards		356.23	265.00
52-215-012-1	0 - 12" w/standards		1069.93	790.00
52-215-612-1	6 - 12" w/standards		733.88	560.00

Prices & Specifications are subject to change without notice.

15

Fowler®

TOOL-A-THON® Vol. 18.2



Find us on social media!

Inch Outside Micrometers

with Decimal Equivalents on Frame

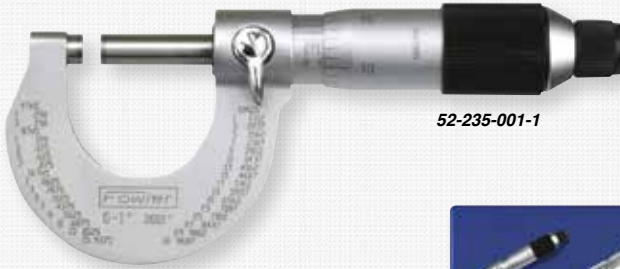

52-235-001-1

52-235-100-0

- Satin chrome finish forged steel frame
- Microfine black graduations
- Anvil and spindle precision ground, with carbide faces
- Ratchet style thimbles for exact and repetitive settings
- Sizes over 1" include standard
- Includes case



Order No.	Range	Accuracy	List Price	Sale Price
52-235-001-1	0 - 1"	± 0.00016"	\$66.24	\$49.00
52-235-002-2	1 - 2"	± 0.00016"	76.67	\$7.00
52-235-003-2	2 - 3"	± 0.0002"	95.84	\$71.00
Set				
52-235-100-0	0 - 3" Set with standards		\$286.54	\$214.00

Swiss-Style Micrometers



52-229-201-0

"Awesome set of mics!"
Erik

Check us out!
YouTube
FowlerVid

- 0.0001" reading
- Carbide measuring faces
- Insulated frame
- Ratchet thimble and locking lever
- Microfine graduations
- Sizes over 1" include standard
- Includes case



52-229-213-0

Order No.	Range	Accuracy	List Price	Sale Price
52-229-201-0	0 - 1"	± 0.00016"	\$53.87	\$40.00
52-229-202-0	1 - 2"	± 0.00016"	63.09	\$7.00
52-229-203-0	2 - 3"	± 0.0002"	77.78	\$8.00
52-229-204-0	3 - 4"	± 0.0002"	89.29	\$6.00
52-229-205-0	4 - 5"	± 0.00024"	110.27	\$2.00
52-229-206-0	5 - 6"	± 0.00024"	129.52	\$9.00
Sets				
52-229-213-0	0 - 3"		\$194.21	\$145.00
52-229-214-0	0 - 4"		274.95	\$206.00
52-229-220-0	0 - 100mm		274.95	\$206.00

Digit Counter Micrometers



52-224-001-0



52-224-103-0

- Digital counter reads to 0.001"
- Resolution: 0.0001" (using vernier)
- Microfine graduations on satin chrome
- Carbide tipped measuring faces
- Positive locking nut on spindle
- Sizes over 1" include standard
- Includes case

Order No.	Range	List Price	Sale Price
52-224-001-0	0 - 1"	\$113.74	\$79.00
52-224-002-0	1 - 2"	119.48	83.00
52-224-003-0	2 - 3"	136.09	95.00
52-224-004-0	3 - 4"	149.70	104.00
52-224-005-0	4 - 5"	158.44	110.00
52-224-006-0	5 - 6"	165.67	116.00
Sets			
52-224-103-0	0 - 3" set	\$359.04	\$251.00
52-224-104-0	0 - 4" set	509.13	356.00
52-224-220-0	0 - 75mm set	378.04	264.00

0 - 0.5" Outside Micrometer



- 0 - 0.5" micrometer by 0.001", satin chrome finish
- Anvil and spindle hardened and precision ground with microlapped ends
- Clear, crisp graduations on barrel and thimble
- Diameter of measuring faces: 0.197"

Order No. 52-230-000-0

Sale \$32.00

List \$39.68

Fowler®

TOOL-A-THON® Vol. 18.2



Find us on social media!

Point Anvil & Spindle Micrometers



54-860-661-0

Absolute Reading!



- 30° pointed anvil and spindle for measuring small grooves, keyways, small flutes, and hard to reach dimensions
- Protected to IP54 specifications
- Large LCD Display, 8.5mm
- Automatic switch off
- Carbide measuring faces
- Absolute & incremental modes
- Sizes over 1"/25mm include standard

Order No.	Range	Resolution	Accuracy	List Price	Sale Price
54-860-661-0	0 - 1"/0 - 25mm	0.00005"/0.001mm	0.00016"/0.004mm	\$181.07	\$135.00
54-860-662-0	1 - 2"/25 - 50mm	0.00005"/0.001mm	0.00016"/0.004mm	198.09	148.00
54-860-663-0	2 - 3"/50 - 75mm	0.00005"/0.001mm	0.0002"/0.005mm	221.55	166.00
54-860-664-0	3 - 4"/75 - 100mm	0.00005"/0.001mm	0.0002"/0.005mm	240.99	180.00

Point Spindle & Blade Anvil Micrometers



54-860-671-0

Absolute Reading!



- 60° pointed spindle with blade anvil for grooves and hard to reach dimensions
- Protected to IP54 specifications
- Large LCD display, 8.5mm
- Automatic switch off
- Hardened steel measuring face
- Absolute & incremental modes
- Sizes over 1"/25mm include standard

Order No.	Range	Resolution	Accuracy	List Price	Sale Price
54-860-671-0	0 - 0.8"/0 - 20mm	0.00005"/0.001mm	0.00016"/0.004mm	\$151.05	\$113.00
54-860-672-0	1.0 - 1.8"/25 - 45.7mm	0.00005"/0.001mm	0.00016"/0.004mm	169.82	127.00
54-860-673-0	2.0 - 2.8"/50 - 71mm	0.00005"/0.001mm	0.0002"/0.005mm	192.30	144.00
54-860-674-0	3.0 - 3.8"/75 - 96.5mm	0.00005"/0.001mm	0.0002"/0.005mm	216.86	162.00

Electronic IP54 Ball Anvil Micrometers



54-860-113-1

Absolute Reading!



- Ball anvil/flat spindle for measuring tubes or the insides of holes to outer edges
- Protected to IP54 specifications
- Large LCD display, 8.5mm
- Automatic switch off
- Hardened steel measuring face
- Absolute & incremental modes
- Sizes over 1"/25mm include standard

Order No.	Range	Resolution	Accuracy	List Price	Sale Price
54-860-113-1	0 - 1"/0 - 25mm	0.00005"/0.001mm	0.00016"/0.004mm	\$124.86	\$93.00
54-860-114-1	1 - 2"/25 - 50mm	0.00005"/0.001mm	0.00016"/0.004mm	146.25	109.00
54-860-115-1	2 - 3"/50 - 75mm	0.00005"/0.001mm	0.0002"/0.005mm	167.97	125.00
54-860-116-1	3 - 4"/75 - 100mm	0.00005"/0.001mm	0.0002"/0.005mm	189.25	141.00

Electronic IP54 Ball Anvil & Spindle Micrometers



54-860-211-1

Absolute Reading!



- Ball anvil and spindle for measuring special curved surfaces
- Protected to IP54 specifications
- Large LCD display, 8.5mm
- Automatic switch off
- Hardened steel measuring face
- Absolute & incremental modes
- Sizes over 1"/25mm include standard

Order No.	Range	Resolution	Accuracy	List Price	Sale Price
54-860-211-1	0 - 1"/0 - 25mm	0.00005"/0.001mm	0.00016"/0.004mm	\$136.09	\$102.00
54-860-212-1	1 - 2"/25 - 50mm	0.00005"/0.001mm	0.00016"/0.004mm	157.05	117.00
54-860-213-1	2 - 3"/50 - 75mm	0.00005"/0.001mm	0.0002"/0.005mm	179.43	134.00
54-860-214-1	3 - 4"/75 - 100mm	0.00005"/0.001mm	0.0002"/0.005mm	202.79	152.00



Interchangeable Anvil Micrometers

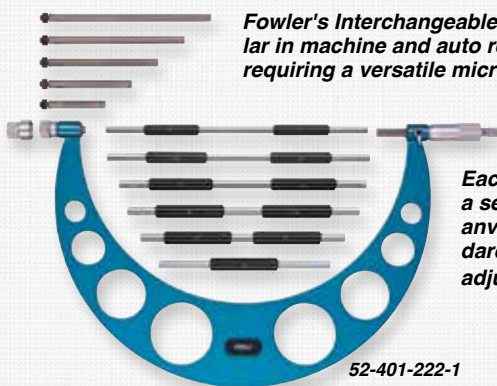

Fowler's Interchangeable Anvil Micrometers are very popular in machine and auto repair and for all other applications requiring a versatile micrometer.

Each micrometer is equipped with a series of easily interchangeable anvils to fulfill the ranges listed. Standards are also included to accurately adjust the required range.

52-401-222-1

- Hammertone blue baked enamel frame
- Graduations are microfine on satin chrome for easy reading
- Each anvil is fitted with an adjusting collar to set the overall dimension
- Spindle thread is hardened and precision ground with microlap finish in carbide tipped measuring faces
- Ratchet stop ensures exact readings
- A wrench is included for fast, easy zero adjustment on the sleeve
- Positive lever locking clamp assures accurate settings
- Standards are included with each set
- Parallelism: 0.0004"
- Flatness: 0.00003"
- Includes case

Order No.	Range	Graduation	Accuracy	List Price	Sale Price
52-401-221-1	0 - 6" w/standards & case	0.0001"	0.00024"	\$254.94	\$185.00
52-401-222-1	6 - 12" w/standards & case	0.0001"	0.00024"	374.42	269.00
52-401-204-1	12 - 16" w/standards & case	0.001"	0.00036"	449.33	320.00
52-401-205-1	16 - 20" w/standards & case	0.001"	0.00036"	524.24	375.00

INDI-X® Indicating Micrometers



52-245-501-0

- Anvil and spindle hardened and precision ground
- Fully insulated frame, satin chrome finish
- Carbide tipped anvil & spindle
- Retracting button conveniently located in relation to operator's hand
- 0 - 1" Range, head graduated in 0.001"
- Flatness: 0.000012"
- Dial graduated in 0.00005"
- Diameter of spindle: 0.256"
- Includes case

Order No.	Range	Accuracy	List Price	Sale Price
52-245-501-0	0 - 1"	0.00016"	\$349.46	\$275.00
52-245-502-0	1 - 2"	0.00016"	405.29	330.00

Electronic IP65 Thread Micrometers



- Water Resistant to IP65 specifications
- True inch/metric conversion
- 60° measuring anvils
- ABS/INC measuring mode
- Positive spindle lock
- Painted enamel and heat insulated frame
- Resolution: 0.00005"/0.001mm
- Friction thimble
- Sizes over 1" include standard

NEW!



Order No.	Range	Thread Range	Accuracy	List Price	Sale Price
54-219-001-0	NEW 0 - 1"	64 - 5 TPI/0.4 - 5mm	± 0.00008"/0.002mm	\$219.30	\$194.00
54-219-002-0	NEW 1 - 2"	44 - 3.5 TPI/0.6 - 7mm	± 0.00008"/0.002mm	234.60	206.00
54-219-003-0	NEW 2 - 3"	24 - 3.5 TPI/1 - 7mm	± 0.00008"/0.002mm	249.90	221.00
54-219-004-0	NEW 3 - 4"	24 - 3.5 TPI/1 - 7mm	± 0.00012"/0.003mm	265.20	233.00

Vernier Thread Micrometers



- 60° measuring anvils
- Painted enamel and heat insulated frame
- Positive spindle lock
- Graduation: 0.001"
- Ratchet thimble
- Sizes over 1" include standard

NEW!

Order No.	Range	Thread Range	Accuracy	List Price	Sale Price
52-219-001-1	NEW 0 - 1"	64 - 5 TPI/0.4 - 5mm	0.00016"	\$81.60	\$73.00
52-219-002-1	NEW 1 - 2"	44 - 3.5 TPI/0.6 - 7mm	0.00016"	91.80	82.00
52-219-003-1	NEW 2 - 3"	24 - 3.5 TPI/1 - 7mm	0.0002"	107.10	95.00
52-219-004-1	NEW 3 - 4"	24 - 3.5 TPI/1 - 7mm	0.0002"	117.30	103.00

Prices & Specifications are subject to change without notice.



0 - 4" Depth Micrometers

- Base surface hardened, ground & lapped
- Ratchet thimble
- Locking clamp
- Rod diameter: 0.176"



52-225-114-0

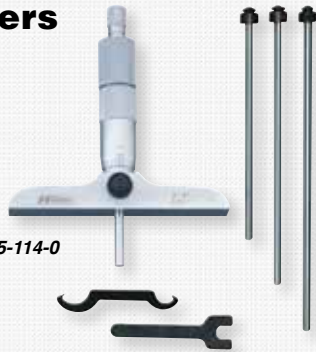

Order No.	Range	Graduation	Base	List Price	Sale Price
52-225-110-0	0 - 4"	0.001"	2.5"	\$135.17	\$110.00
52-225-114-0	0 - 4"	0.001"	4"	146.01	120.00

0 - 6" Digit Counter Depth Micrometers

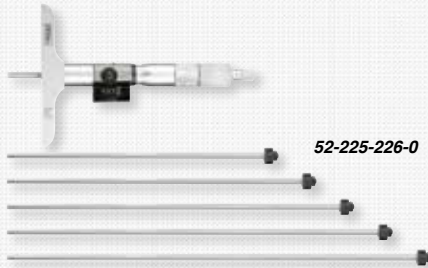

52-225-226-0

- Easy-to-read digit counter
- Microfine 0.001" graduations
- 4" base constructed of tool steel, hardened and ground
- Satin chrome finish
- Ratchet thimble
- Locking clamp
- Rod diameter: 0.176"
- Includes wrench and fitted case

Order No.	Range	Graduation	Base	List Price	Sale Price
52-225-176-0	0 - 6"	0.001"	2.5"	\$193.76	\$150.00
52-225-226-0	0 - 6"	0.001"	4"	200.38	155.00

IP54 Electronic Depth Micrometer



- Range: 0 - 6"/150 mm
- Resolution: 0.00005"/0.001mm
- Hardened tool steel, precision ground and microlapped 4" base
- Rod diameter: 0.176"
- Protected to IP54 standards
- Automatic switch off
- Large LCD display
- Includes fitted case

Order No. 54-225-456-0

Sale \$175.00

List 227.07

X-PROOF® 0 - 22" Dial Depth Gage

with IP54 protection!

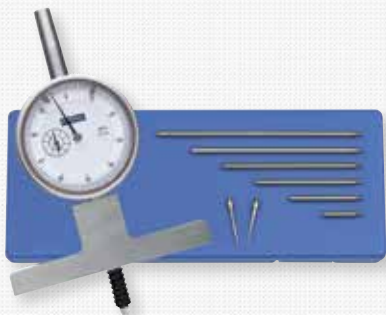

- 0-1" AGD Group 2 IP54 Indicator
- Sealed bezel, top cap and dial with bellows on stem
- Sealed back plate
- .001" graduations
- 4" base ground and lapped for flatness
- Rods connect for 22" capacity
- Includes 2 extra points (spline & needle)
- Tolerance markers



Order No. 52-125-007-0

Sale \$99.00

List \$214.27

X-DEPTH 22" 0 - 22" Depth Gage

Twice the range of competitive products!

- 0 - 1" travel indicator
- 0.001" Graduations
- Rods connect together for full 22" capacity
- Satin chrome finish
- Base size: 4"
- Includes 2 extra points for small hole applications; one 0.078" dia. x 1" long and one needle point x 1" long



Order No. 52-125-006-1

Sale \$135.00

List \$184.27



X-DEPTH 22" E 0 - 22" Electronic Depth Gage



- 0 - 1" travel electronic indicator
- Zero reset at any position
- On/off button
- Relative/absolute measuring
- Bottom surface of the base is hardened, ground & lapped
- Full 22" range
- Resolution .0005"/.01mm
- Hold feature
- 4" Base
- Includes 2 extra points for small hole applications; one 0.078" dia. x 1" long and one needle point x 1" long

Order No. 54-125-777-0

Sale \$205.00

List \$265.75



Fowler®

TOOL-A-THON® Vol. 18.2



Find us on social media!





LIFETIME WARRANTY

We are so confident that these Fowler-Sylvac Mark VI electronic indicators are the most accurate, most dependable, best made products you can buy, we are extending the warranty to last a lifetime!

Quality, accuracy, dependability, world-class customer service and now a real Lifetime Warranty!

*No Gimmicks
No Hurdles
No Nonsense*

Mark VI Electronic Indicators

- Robust construction
- Repeatability: 2µm
- Output: Proximity/Power - USB/RS-232/digimatic/Wireless
- Menus customizable with free software
- Wide range of functions (MIN/MAX/DELTA, TOL, Factor, Preset, Auto Off, etc)
- Bezel rotates 270°
- Large display with LED tolerance indicators
- Includes lug back

NOW
available with
ISO Cert.



This Button is programmable for common functions

54-530-135-0

54-530-535-0



Learn more at



Order No.	Description	Maximum Error	Resolution	List Price	Sale Price
54-530-125-0	0 - 0.500"/12.5mm	0.0004"/0.01mm	0.0005"/0.01mm	\$439.37	\$395.00
54-530-135-0	0 - 0.500"/12.5mm	0.00012"/0.003mm	0.00005"/0.001mm	562.60	499.00
54-530-145-0	0 - 1"/25mm	0.0004"/0.01mm	0.0005"/0.01mm	501.47	450.00
54-530-155-0	0 - 1"/25mm	0.00016"/0.004mm	0.00005"/0.001mm	600.11	540.00
54-530-155-C	NEW 1"/25mm with ISO/A2LA Certification				565.00
54-530-175-0	0 - 2"/50mm	0.00019"/0.005mm	0.00005"/0.001mm	\$1135.91	1015.00
Bluetooth					
54-530-335-0	0 - 0.500"/12.5mm	0.00012"/0.003mm	0.00005"/0.001mm	\$696.55	\$620.00
54-530-355-0	0 - 1"/25mm	0.00016"/0.004mm	0.00005"/0.001mm	744.82	665.00
Accessory					
54-115-246-BT	USB Bluetooth Receiver			\$49.25	\$44.00
Analog Display					
54-530-535-0	0 - 0.500"/12.5mm	0.00012"/0.003mm	0.00005"/0.001mm	\$632.25	\$565.00
54-530-555-0	0 - 1.00"/25mm	0.00016"/0.004mm	0.00005"/0.001mm	691.24	615.00

High Accuracy Inspection Set

NEW!

Indicator features (54-530-700-0):

- Resolution 0.000005"/0.0001mm
- Repeatability 0.00001"/0.0002mm
- Accuracy 0.00006"/0.0015mm
- 2"/50mm measuring range
- IP54 rated
- Includes spindle lifting attachment
- Mixed ceramic bearing/ball bearing system
- 8mm mounting diameter

Dial Stand features (54-618-578-0):

- Ceramic measuring surface provides durability and micro flatness
- Serrated working surface for stability and accuracy
- Rack and pinion measuring column for fine measurements
- Working area 4" x 4"/100 x 100mm
- Flatness 0.00015"
- Measuring range 8"/200mm



**Save
over
\$400.00**



Fowler
TOOL-A-THON® Vol. 18.2



Find us on social media!

Order No.	Description	List Price	Sale Price
54-618-580-0	High Accuracy Inspection Set includes stand and indicator	\$3432.30	\$3000.00
Connectivity Cables			
54-115-526-0	Proximity cable with USB connection	\$138.79	\$125.00
54-115-527-0	Proximity cable with serial connection	138.79	125.00

Prices & Specifications are subject to change without notice.

Fowler Bluetooth

Ultra-Cal VI Electronic Calipers *page 6*



Rapid-Mic *page 12*



**Mark VI
Electronic Indicators**
page 24



for virtually every application!

**XTH3 Holematic Pistol Grips Sets and
XTD3 Holemike Sets** *pages 2 & 3*



**V Series
Height
Gages**
pages 28 & 29



zCAT



Fowler
TOOL-A-THON® Vol. 18.2



Find us on social media!
[f](#) [E](#) [in](#) [You](#)



Fowler - Trimos V3, V4 & V5 Electronic Height Gages

The Fowler-Trimos V3, V4 and V5 vertical measuring instruments have been developed for the most difficult workshop environments. Manufactured in their entirety in Switzerland, they guarantee a robust, precise and reliable product in the long run.

- "Black mask" display with user friendly functions
- Electronically adjustable measuring force 0.75/1.5 (N)
- Lithium-ion rechargeable batteries
- All adjustments possible without tools
- Cast iron base for optimal stability
- RS-232 and USB interfaces requires 54-192-112-0 cable
- Dual probe holders (V4 and V5 Only)
- Carriage displacement: Manual
(V5 includes selectable manual or motorized carriage displacement)
- Measures heights, diameters, perpendicularity, center-lines, Min/Max/Delta
- Resolution: 0.00005"/0.001mm
- Repeatability (2s): 0.00008"/0.002mm (Ø)
0.00016"/0.004mm)

All V Models Include:

- Charging unit
- Measuring insert with ruby ball Ø4mm
- Probe holder elbow Ø 8mm
- Setting gage
- User's manual and test certificate



54-192-340-0

V3	54-192-340-0	54-192-370-0
Measuring Range	16"/407mm	28"/711mm
Range with Probe inverted	20"/508mm	31.9"/812mm
Max. Permissible Errors	0.00028"/0.007mm	0.00032"/0.008mm
Frontal Squareness Deviation	0.0004"/0.010mm	0.0006"/0.015mm
Air Cushion		NO



V4	54-191-440-0	54-191-470-0
Measuring Range	16"/407mm	28"/711mm
Range with Probe inverted	28.3"/719mm	40.2"/1023mm
Max. Permissible Errors	0.00022"/0.005mm	0.00028"/0.007mm
Frontal Squareness Deviation	0.0004"/0.010mm	0.0006"/0.015mm
Air Cushion		YES



V5	54-199-540-0	54-199-570-0	54-199-590-0
Measuring Range	16"/407mm	28"/711mm	43.7"/1110mm
Range with Probe inverted	28.3"/719mm	40.2"/1023mm	56"/1422mm
Max. Permissible Errors (µm)		2.5 + L(mm)/300	
Frontal Squareness Deviation	0.00022"/0.005mm	0.00032"/0.008mm	0.00043"/0.011mm
Air Cushion		YES	

Order No.	Description
54-192-340-0	V3 Height Gage
54-192-370-0	V3 Height Gage
54-191-440-0	V4 Height Gage
54-191-470-0	V4 Height Gage
54-199-540-0	V5 Height Gage
54-199-570-0	V5 Height Gage
54-199-590-0	V5 Height Gage
Probe Sets	
54-199-105-0	4mm Probe Set, 21 piece
54-199-106-0	8mm Probe Set, 16 piece
54-199-107-0	Economy Probe Set, 7 piece
Accessories	
54-199-400-0	12"/300mm Holder - for 8mm probes
54-199-021-BT	NEW Bluetooth module
54-115-246-BT	Bluetooth receiver
54-777-120-0	Vmux software - for connecting multiple units to one PC

NEW Bluetooth Module Available!

**EXTREMELY
Easy to Use!**



54-191-440-0



54-199-570-0

Watch the Demo!



NOW
available with
ISO Cert.

Contact the Fowler
Sales Department 1-800-788-2353

Range	List Price	Sale Price
16"/407mm	\$4453.95	\$4100.00
28"/711mm	4910.69	4465.00
16"/407mm	5866.82	5330.00
28"/711mm	6825.02	6200.00
16"/407mm	6466.09	5800.00
28"/711mm	7662.55	6950.00
43"/1100mm	11,853.28	10,700.00
	\$1713.54	\$1500.00
	1278.65	1190.00
	453.90	420.00
	\$959.15	\$890.00
	494.70	460.00
	49.25	44.00
	451.76	411.00

Prices & Specifications are subject to change without notice.





Fowler-Sylvac Hi_Cal Electronic Height Gages

- Extra low measuring force, from 0.2N
- Measure internal and external diameters, centerlines, heights, widths, depths and MIN/MAX/TIR capability
- Excellent repeatability thanks to the motorized carriage
- High reliability
- Data output USB and RS-232
- Battery life: 40 hours rechargeable during operation
- Touch sensitive probe speed for easy operation
- Base with small footprint
- Includes: protective cover, charging set, ruby ball probe Ø3mm, setting gage and calibration certificate



54-931-150-0

NOW
available with
ISO Cert.

Accessory Probe Sets



54-930-215-0



54-930-217-0

FREE 1mm Ball Probe with

Order No.	Range
54-931-150-0	6"/150mm
54-931-150-C	NEW 6"/150mm with ISO/A2LA Certification
54-931-300-0	12"/300mm
54-931-300-C	NEW 12"/300mm with ISO/A2LA Certification
54-931-450-0	17.5"/450mm
54-931-450-C	NEW 17.5"/450mm with ISO/A2LA Certification
Accessories	
54-930-215-0	Full Probe Accessory Set
54-930-217-0	Basic Probe Accessory Set



Watch the Demo!
YouTube
FowlerVid



FREE Basic Probe Set
 with 54-931-450-0 Hi_Cal Purchase
\$605.00 Value!

6"/150mm & 12"/300mm Hi_Cal Purchase

Accuracy	List Price	Sale Price
0.00013"/0.0034mm	\$4754.73	\$4250.00
0.00016"/0.0042mm	5464.18	4950.00
0.00020"/0.005mm	5973.56	5350.00
	\$1115.83	\$995.00
	605.51	550.00

Prices & Specifications are subject to change without notice.



Twin Beam Dial Height Gages

- Separate digit counters register both upward & downward travel
- Zero setting can be obtained throughout the gage's range
- Coarse readings in 0.100" graduations: fine readings taken on indicator are 0.001"
- Dual chrome plated beams
- Carbide-tipped scriber.
- Base is hardened, ground & lapped for maximum flatness

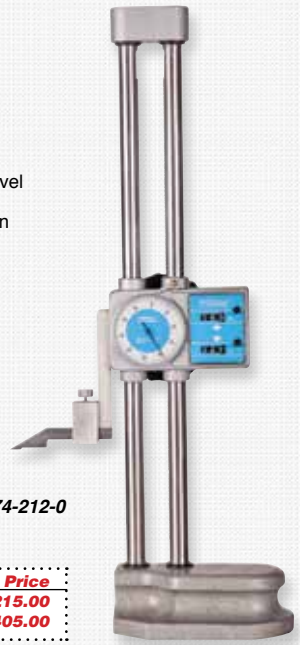

52-174-212-0

Order No.	Range	Accuracy	List Price	Sale Price
52-174-212-0	12"	± 0.0015"	\$290.70	\$215.00
52-174-224-0	24"	± 0.002"	484.50	405.00

Twin Beam Electronic Height Gages *with Offset Scriber*

Optional contact sensor can be used to indicate when measuring contact is made between the gage and another conductive surface →



- Carriage design with offset scriber holder
- Base is ground and lapped for flatness
- Handwheel provides course and fine movement
- Updated electronic and mechanical design offers better accuracy and movement of carriage
- Carbide tipped scriber
- Functions include preset, in/mm conversion and ABS/INC for direct or comparative measuring



54-174-212-3

Order No.	Range	Accuracy	List Price	Sale Price
54-174-212-3	0 - 12"/0 - 300mm	± 0.0016"/0.04mm	\$484.50	\$425.00
54-174-224-3	0 - 24"/0 - 600mm	± 0.002"/0.05mm	678.30	595.00
Accessory				
54-174-226-0	NEW Contact Sensor		\$21.42	\$18.00

Z-HEIGHT PLUS+

Electronic Height Gages

New Design! **NEW!**

- **NEW** base design with painted enamel finish has a more comfortable grip and is finely ground and lapped for smooth movement on surface plates
- **NEW** fine adjust feature allows precise adjustment to required settings
- **NEW** preset feature allows setting pre-determined or reference measurements
- **NEW** 2 indicator holding bars included (3/8" and 8mm)
- Direct inch/metric conversion
- Resolution 0.0005"/0.01mm
- Floating zero
- Large, high contrast LCD display
- Coarse adjustment hand wheel
- Carriage locking lever
- Carbide tipped scriber

54-175-024-0



Order No.	Range	Accuracy	List Price	Sale Price
54-175-012-0	NEW 12"/300mm	± 0.0016"/0.04mm	\$514.27	\$385.00
54-175-018-0	NEW 18"/500mm	± 0.002"/0.05mm	599.58	450.00
54-175-024-0	NEW 24"/600mm	± 0.002"/0.05mm	674.89	510.00

Electronic Height Gages

An economical height gage that offers high quality, accuracy and durability.

- Large base for easy movement
- True inch/metric conversion
- Resolution: 0.0005"/.01mm
- Repeatability: 0.0005"/0.01mm (±2s)
- Deluxe wooden case with reinforced metal edges
- Large easy to read LCD
- Non-glare chrome reading surface
- Overall height: 28"
- Beam thickness: 1.25 X 0.4"
- Presetable display

54-106-020-0



Order No.	Range	Accuracy	List Price	Sale Price
54-106-020-0	20"/500mm	± 0.0025"	\$417.82	\$305.00
54-106-040-0	40"/1000mm	± 0.0035"	1922.25	1350.00

Fowler® TOOL-A-THON® Vol. 18.2



Find us on social media!

INDI-X^{blue}

Electronic Indicators

INCH • METRIC • FRACTION™

- 2-1/4" dial face
- Lugback and 3/8" stem mountings
- Resolution 0.0005"/0.01mm
- Tolerance function
- Absolute/incremental reading
- Floating zero

54-520-250-0

"Easy to use, easy to read, top notch accuracy"

Mr. R.

54-520-260-0



Carbide-tipped point!



Order No.	Description	List Price	Sale Price
54-520-255-0	0.50"/12.5mm Indi-X Blue	\$101.06	\$70.00
54-520-250-0	1"/25mm Indi-X Blue	108.81	75.00
54-520-260-0	1"/25mm/64ths Indi-X Blue Inch-Metric-Fraction	110.40	80.00

AGD or INDI-X^{blue} Indicator & Stand Combo

Stand (52-580-030-0):

- 6" x 6" x 2" granite base
- Positive lock screw
- Fine adjustment knob for zero setting
- Column height is 8"
- Microscrew fingertip control

Black Face Indicator (52-520-109-0):

- Reading: 0.001"
- 1" Travel
- AGD Group 2
- Dial diameter: 2-1/4"
- Continuous reading: 0 - 100

Indi-X Blue Electronic Indicator (54-520-250-0):

- Direct Inch/Metric Conversion
- 1"/25mm travel
- Lugback and 3/8" stem mountings
- Resolution 0.0005"/.01mm
- Tolerance indicators
- Absolute/incremental reading
- Floating zero
- Carbide tipped point



Order No.	Description	List Price	Sale Price
52-580-109-0	Black Face Indicator and Stand Combo	\$183.19	\$135.00
54-580-250-0	Indi-X Blue Electronic Indicator and Stand Combo	239.08	170.00

Fine Adjust Mag Base Sets

With **INDI-X Blue** Electronic Indicator or AGD White Face Indicator

Magnetic Base (52-585-005-0):

- 85 lb. pull
- Fine adjustment
- V-bottom base

Included Magnetic Indicator Back for mounting to most metal surfaces!



54-585-075-0

Magnetic Indicator (52-585-495-0):

- Use for positioning the indicator on most metal surfaces
- Protective coating

Indi-X Blue Indicator (54-520-250-0):

- Direct Inch/Metric Conversion
- 1" / 25mm travel
- Auto Off feature
- 2-1/4" dial face
- Lugback and 3/8" stem mountings
- Resolution .0005"/.01mm
- Tolerance indicators
- Absolute/incremental reading
- Floating zero
- Carbide tipped point with 4-48 thread



52-585-125-0



AGD Indicator (52-520-110-0):

- AGD Group 2
- Dial diameter: 2-1/4"
- Travel: 1"
- Reading: .001"
- Continuous reading: 0.100"
- Carbide tipped point with 4-48 thread

Order No.	Description	List Price	Sale Price
52-585-125-0	Fine Adjust Mag Base with AGD Dial Indicator Set	\$165.78	\$135.00
54-585-075-0	Fine Adjust Mag Base with Indi-X Blue Electronic Indicator Set	216.69	170.00

HOLDXTEC Holding Systems

- All accept 3/8" indicators
- Mag base and HOLD-TEC with fine adjust also accepts 8mm indicators
- All have dovetail clamps for test indicators
- Mag base features 2 fine adjusts making it a **6-Axis Mag Base**
- HOLD-TEC can be mounted in drill chucks, collets, dial gage stands with 8mm mount diameter to make a quick transfer stand
- Mag base has 180 lb. pull
- Adjust to any position
- Powerful On/Off mag base
- Central locking system



Features Double Fine Adjust



52-585-085-0

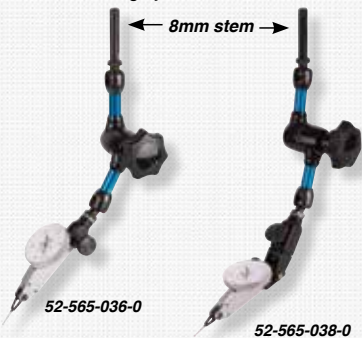

52-565-036-0

52-565-038-0

Order No.	Description	List Price	Sale Price
52-585-085-0	HOLD-Tec Mag Base with Double Fine Adjust	\$162.57	\$95.00
52-565-036-0	HOLD-Tec without Fine Adjust	91.31	62.00
52-565-038-0	HOLD-Tec with Fine Adjust	99.24	65.00

Prices & Specifications are subject to change without notice.

Premium Dial Indicators



52-520-125-0



52-520-110-2



52-520-110-1



52-520-120-0



- Tolerance markers
- Solid steel housing
- Carbide contact point

Includes NIST Certificate of Calibration

Order No.	Range	Graduation	Reading	Balanced Reading	Dial Color	List Price	Sale Price
52-520-110-1	1"	0.001"	0 - 100	—	Black Face	\$91.09	\$60.00
52-520-110-2	1"	0.001"	0 - 100	—	White Face	91.09	60.00
52-520-105-0	0.500"	0.001"	0 - 100	0 - 50 - 0	White Face	86.16	57.00
52-520-120-0	2"	0.001"	0 - 100	0 - 50 - 0	White Face	140.92	96.00
52-520-129-0	1"	0.0005"	0 - 50	0 - 25 - 0	White Face	110.16	74.00
52-520-125-0	0.250"	0.0005"	0 - 50	0 - 25 - 0	White Face	120.24	81.00
52-520-500-0	25mm	0.01mm	0 - 100	0 - 50 - 0	White Face	138.67	94.00

Premium IP54 Shockproof Dial Indicators

- Includes NIST Certification
- Includes both center lug back and flat back
- Steel housing
- Sealed plunger, dustcap and back plate
- Carbide contact point
- 0 - 100 dial reading with rev. counter

Learn more at ...
YouTube
FowlerVid



52-520-460-0



52-520-465-0



Order No.	Range	Graduation	Reading	Contact Point	List Price	Sale Price
52-520-460-0	1"	0.001"	0 - 100	4 - 48 (3/8" stem)	\$98.84	\$65.00
52-520-465-0	1"	0.001"	0 - 100	4 - 48 (3/8" stem)	98.84	65.00

DUAL **PLUS+** Dial Indicator

- Two dial indicators in one
- Inch on one side and metric on the opposite side
- Range: 0.5"/12.5mm
- Graduation: 0.001"/0.01mm
- 8mm mounting stem with 3/8" adaptor bushing included
- Jeweled movements
- Carbide contact point
- 1" spline contact point included
- Includes NIST certificate for both inch and metric readings



Inch Reading Side



Metric Reading Side



Order No. 52-530-115-0

Sale \$95.00

List \$107.10

Depth Base Attachment



- Turn your dial or electronic indicator into a depth gage (may reduce range)
- 4" length
- Fits indicators with 3/8" or 8mm mounting stem, adaptor bushing included
- Ground and lapped base

Order No. 52-125-004-0

Sale \$18.00

List \$40.08

Indicator Chucks



- Low carbon steel, black oxide finished
- 0.0140" - 0.040" chucking capacity
- Can be used with small pin gages for special or restricted applications
- Available in both 4 - 48 and M2.5 threads



Indicator shown not included

Order No.	Description	List Price	Sale Price
52-526-020-0	Indicator Chuck with 4 - 48 thread	\$23.46	\$20.00
52-526-021-0	Indicator Chuck with M2.5 thread	23.46	20.00



XTEST Indicators

- Solid copper body
- Super smooth jeweled movement
- Smoother bezel adjustment for easier zero setting
- 0.080" and 0.120" carbide ball contact points (0.040" steel ball)
- 0.060" range with auto reverse and rev. counter
- Easy to read tilted dial
- 5/32" pivotable stem



**Includes NIST
Certificate of Calibration**

52-562-001-0

52-562-002-0

Order No.	Style	Graduations	Dial Diameter	Dial Reading	List Price	Sale Price
52-562-001-0	Horizontal	0.0005"	1-1/2"	0-15-0	\$129.76	\$99.00
52-562-002-0	Horizontal	0.0005"	1"	0-15-0	129.76	\$99.00

XTEST Indicator

TWICE the range of most indicators!

**Includes NIST
Certificate of Calibration**

- Vertical style
- Graduations: 0.0005"
- Dial diameter: 1" and dial reading: 0 - 15 - 0
- Solid copper body and super smooth jeweled movement
- Smoother bezel adjustment for easier zero setting
- 0.080" and 0.120" carbide ball contact points (0.040" steel ball)
- 0.060" range with auto reverse and rev. counter
- 5/32" pivotable stem

Order No. 52-562-005-0

Sale \$99.00

List \$142.10



Verdict Long Reach Test Indicator



3.077"

- Range: 0.080"
- 3.077" extra long contact point
- Graduations: 0.001"
- Includes one extra contact point
- Jeweled movement
- Automatic reversal
- Dovetails on top and bottom of main body
- Includes fitted case

Order No. 52-555-022-0

Sale \$250.00

List \$326.28

NEW!

Test Indicators

All Fowler Test Indicators include bi-directional constant clockwise rotation, automatic reversal, three dovetail mountings, jeweled movement, two dovetail clamps and a molded case.



52-562-776-0



52-562-780-0



Extra Points

.040" .120"

Order No.	Face Color	Total Range	Dial Reading	Graduation	Dial Diameter	Point Length	List Price	Sale Price
52-562-774-0	white	0.030"	0-15-0	0.001"	1"	1/2"	\$121.98	\$80.00
52-562-776-0	white	0.030"	0-15-0	0.0005"	1-1/2"	1/2"	135.57	80.00
52-562-780-0	black	0.030"	0-15-0	0.0005"	1-1/2"	1/2"	135.57	80.00



52-563-772-0



52-563-777-0

Extra Points

.040" .120"

Order No.	Face Color	Total Range	Dial Reading	Graduation	Dial Diameter	Point Length	List Price	Sale Price
52-563-770-0	white	0.008"	0-4-0	0.0001"	1"	1/2"	\$129.62	\$90.00
52-563-771-0	black	0.008"	0-4-0	0.0001"	1"	1/2"	129.62	90.00
52-563-777-0	white	0.008"	0-4-0	0.0001"	1-1/2"	1/2"	129.62	90.00
52-563-772-0	black	0.008"	0-4-0	0.0001"	1-1/2"	1/2"	129.62	90.00



52-562-784-0

Extra Points

.040" .120"

Order No.	Face Color	Total Range	Dial Reading	Graduation	Dial Diameter	Point Length	List Price	Sale Price
52-562-781-0	white	.020"	0-10-0	.0005"	1"	1-7/16"	\$133.55	\$90.00
52-562-782-0	black	.020"	0-10-0	.0005"	1"	1-7/16"	133.55	90.00
52-562-783-0	white	.020"	0-10-0	.0005"	1-1/2"	1-7/16"	133.55	90.00
52-562-784-0	black	.020"	0-10-0	.0005"	1-1/2"	1-7/16"	133.55	90.00

Prices & Specifications are subject to change without notice.





XTENDER

1.4" to 6" Dial Bore Gage Set with Carbide Anvils

Industry's two most popular bore gage ranges combined in one easy-to-use electronic set!

Preset size of master for absolute reading and use minimum hold feature to lock on the bore size as the gage is rocked in the part to be measured.



Bore Gage Features:

- Range: 1.4"-6"/35mm-150mm
- Carbide anvils
- Self-centering

Indicator Features:

- Bar graph and numeric digital display
- Resolution: 0.00005"/0.001mm
- Preset with recall
- ABS/INC measurement
- Min/Max/TIR

*"Excellent quality,
well built."*

Lee C.



Learn more at ...



Order No.	Description	List Price	Sale Price
54-646-401-0	1.4" - 6" Electronic Bore Gage Set	\$333.27	\$255.00
52-646-450-0	20" Depth Extension	83.23	74.00
52-646-475-0	40" Depth Extension	104.04	93.00

0.7 - 1.5" Dial Bore Gage Set

Carbide anvils

- Easy-to-read
- Economical
- Insulated grip
- Graduation: 0.0005"



Order No. 52-646-100-0

Sale \$117.00

List \$153.56

XTENDER

1.4" to 6" or 35mm to 160mm Dial Bore Gage Sets with Carbide Anvils

Industry's two most popular bore gage ranges combined in one set!

Carbide Anvils

- Easy-to-read
- Graduation: 0.0005" or 0.01mm
- Insulated grip
- 1.4" to 6" range or 35 to 160mm



52-646-400-0

Order No.	Range	Graduation	List Price	Sale Price
52-646-300-0	2 - 6"	0.0005"	\$126.88	\$110.00
52-646-400-0	1.4 - 6"	0.0005"	192.89	140.00
52-646-500-0	1.4 - 6"	0.0001"	241.72	180.00
52-646-220-0	35 - 160mm	0.01mm	213.15	135.00
52-646-450-0	20" Depth Extension		83.23	74.00
52-646-475-0	40" Depth Extension		104.04	93.00

XTENDER PLUS+ Bore Gage Set

- Range: 1.4 - 6"
- Fitted with a Sylvac lifetime warranty electronic indicator (54-530-535-0)
- Analog scale for reversal point detection
- IP54 rated indicator
- Carbide tipped anvils
- Resolution: 0.00005"/0.001mm
- Min/Max/TIR readings
- Supplied in a fitted case

NEW!



Order No. 54-646-535-0

Sale \$705.00 List \$785.00

Bore Gage Setting Master Kits - Inch & Metric

Fowler's Bore Gage Setting Master Kit is used for accurately setting any bore gage up to 6"/150mm in diameter to an accuracy of 0.0001"/0.003mm

Each Set includes:

Setting Device (53-646-000-1 - Inch Model)

- Base anvil: 3.950" x 1.050"
- Adjustable anvil 2.375" x .375" (two each)
- Internal capacity: 6"/150mm
- Depth capacity: 1"/25mm
- Centralizer capacity width: 2.750"
- Quick-release holder for fast adjustment
- **Can also be used for external setting, depending on application (external mics, snap gages, caliper gages)**

Economy Gage Block Sets

Inch model:

- 36 piece
- Tolerances to .00005"
- Certificate of Calibration to NIST

Metric model:

- 33 piece
- AS-2 grade
- Certificate of Calibration to NIST



53-646-000-1

Includes:
Bore gage setting master and gage block set.
All in a custom-fitted case!



Order No.	Description	List Price	Sale Price
53-646-000-1	Inch Bore Gage Setting Master Kit	\$309.49	\$225.00
53-646-010-0	Metric Bore Gage Setting Master Kit	322.50	235.00
53-646-005-0	Bore Gage Setting Master Kit - without Gage Blocks	178.50	160.00

Prices & Specifications are subject to change without notice.



Internal & External Electronic Caliper Gages



54-554-611-0



54-554-711-0

- Rugged housing
- Large, LCD display
- Resolution: 0.0002"/0.005mm
- Accuracy: $\pm 0.0008"/\pm 0.02$ mm
- Preset capability
- Absolute/Incremental measurements
- High-impact, aircraft aluminum case



Dimensions for Internal Calipers					
Metric	Inch	L	S	H	Tip Radius
5-15mm	0.2-0.6"	20mm	1.0mm	1.5mm	0.3mm
5-25mm	0.2-1.0"	35mm	1mm	1.5mm	0.3mm
10-30mm	0.4-1.2"	55mm	2mm	3.5mm	0.5mm
20-40mm	0.8-1.6"	80mm	3mm	6.5mm	0.5mm
30-50mm	1.2-2.0"	80mm	3mm	8.5mm	0.5mm

Dimensions for External Calipers					
Metric	Inch	L	S	H	Tip Radius
0-10mm	0-0.4"	40mm	3mm	8mm	0.5mm
0-20mm	0-0.8"	80mm	6.5mm	25mm	0.75mm
10-30mm	0.4-1.2"	80mm	6.5mm	25mm	0.75mm
20-40mm	0.8-1.6"	80mm	6.5mm	25mm	0.75mm
30-50mm	1.2-2.0"	80mm	6.5mm	25mm	0.75mm

Internal Caliper Gages

Order No.	Range	List Price	Sale Price
54-554-611-0	0.200" - 0.590"/5 - 15mm	\$188.03	\$145.00
54-554-622-0	0.200" - 1"/5 - 25mm	201.71	155.00
54-554-623-0	0.400" - 1.2"/10 - 30mm	211.08	165.00
54-554-624-0	0.790" - 1.6"/20 - 40mm	211.08	165.00
54-554-625-0	1.2" - 2"/30 - 50mm	211.08	165.00

External Caliper Gages

Order No.	Range	List Price	Sale Price
54-554-711-0	0 - 0.400"/0 - 10mm	\$188.03	\$145.00
54-554-722-0	0 - 0.790"/0 - 20mm	201.71	155.00
54-554-723-0	0.4" - 1.2"/10 - 30mm	211.08	165.00
54-554-724-0	0.790" - 1.6"/20 - 40mm	211.08	165.00
54-554-725-0	1.2" - 2"/30 - 50mm	211.08	165.00

XTA-VALUE Internal & External Electronic Caliper Gages



Check us out!
YouTube
FowlerVid

INCH • METRIC • FRACTION

- Robust housing
- Large LCD display
- Reading: 0.01"/0.1mm/1/64ths
- Accuracy: 0.01"/0.3mm/1/64ths
- Battery: CR2032
- Spring loaded with locking nut



Order No.	Description	Range	List Price	Sale Price
54-554-630-0	Outside Caliper Gage	0 - 6"/0 - 150mm	\$51.26	\$32.00
54-554-730-0	Inside Caliper Gage	0.5 - 6"/12.7 - 150mm	51.26	32.00
Set				
54-554-650-0	NEW Inside/Outside Caliper Gage Set includes 4" internal setting master		\$91.80	\$60.00

XTRA-VALUE 9" Electronic Level



- Measuring range: 4 x 90°
- Resolution: 0.05°
- Accuracy: ± 0.2°
- Repeatability: ± 0.05
- Standard 9 volt battery (250 hours life)
- Dimensions: 9"L x 1"W x 2-1/4"H
- Includes two-way level and plumb vials
- Reversible reading for inverted use

Order No. 54-440-600-0

Sale \$62.00

List \$77.80

mini-MAG Protractor™ & Machinist Screw Jack Set



NEW! Special Promo Package

Support your inspection parts with the Machinist Jack Set and KNOW it's level with the mini-Mag Protractor!

The mini-MAG Protractor provides instant 360° digital inclination display of any angle with the additional unique feature of embedded magnets on both sides and the bottom which make it ideal for a variety of measurements.



"This unit is so accurate, it scares the welders."
G.P.



Learn more at ...

YouTube
FowlerVid



Display inverts for easy reading!

Mini Mag Protractor

- Uses standard 9V battery (250 hrs.)
- Measuring range: 360° (4 x 90°)
- Resolution: 0.05°
- Accuracy: ± 0.2°
- Repeatability: 0.05°
- Dimensions 2.375" x 1.375" x 2.375"
- Hold feature

Machinist Screw Jack Set

- 1-1/12" base for added stability
- 3 - 4" height range
- 1,000 lb. capacity
- Tilting swivel head with lock nut

Order No.	Description	List Price	Sale Price
54-422-450-P	NEW Mini Mag and Machinist Screw Jack PLUS Set	\$118.15	\$64.00
54-422-450-1	Mini-Mag Protractor	103.65	55.00
52-104-025-0	Machinist Screw Jack Set	19.34	15.00

Prices & Specifications are subject to change without notice.

43

Fowler® TOOL-A-THON® Vol. 18.2



Find us on social media!

Machinist Spirit Levels

Used for setting up machinery and other work that requires extreme leveling accuracy!

- Steel construction
- Heat insulated
- V's on base. Frame level includes V on one vertical base.
- Precision ground for accuracy
- Available in 2 sensitivities
- Auxiliary vial used to ensure level is set properly on round items
- Includes fitted case



53-422-158-2



53-422-006-2

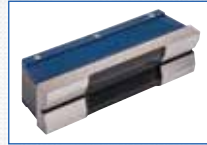

Order No.	Description	List Price	Sale Price
53-422-006-2	NEW 6" Machinist Level 0.0002" graduations	\$105.00	\$94.00
53-422-008-2	NEW 8" Machinist Level 0.0002" graduations	120.00	108.00
53-422-012-2	NEW 12" Machinist Level 0.0002" graduations	145.00	130.00
53-422-006-5	NEW 6" Machinist Level 0.0005" graduations	100.00	90.00
53-422-008-5	NEW 8" Machinist Level 0.0005" graduations	115.00	103.00
53-422-158-2	NEW 8" Machinist Frame Level 0.0002" graduations	165.00	148.00
53-422-158-5	NEW 8" Machinist Frame Level 0.0005" graduations	160.00	144.00

Portable Durometers

Fowler's Portable Durometers are just right for testing the hardness of flexible materials such as rubber and plastics. These gages conform to shore scales.

- Manufactured in accordance with DIN, ASTM, ISO and JIS specifications
- Includes reference test block, operating instructions and fitted case



Applications:

35° Blunt Taper Durometers are suitable for testing soft and natural rubber products, neoprene, polyesters, soft PVS, leather, thiokol, nitril rubbers, wax, felt and more.

Sharp 30° point Durometers are ideal for testing hard rubber, hard synthetic materials, e.g. acrylics, glass, polystyrol, thermoplastics, printing rolls, vinyl sheets, cellulose acetates, densified wood, etc.

Order No.	Penetrator	Shore Scale	List Price	Sale Price
53-762-301-0	Blunt taper 35°	A	\$133.71	\$110.00
53-762-302-0	Sharp 30°	D	153.88	130.00

Indicator & Mini Mag Set

- AGD group 1 indicator
- 0.250" range
- 0.001" graduations, 0-100 reading
- Tolerance markers
- Carbide contact point
- Mag base with fine adjust (also accepts test indicators with dovetails), base measures 1.8" x 1.2"
- On/off switch for secure holding and easy removal
- 37 lbs. of magnetic pull
- 22 piece contact point set — flat, radius, cone and spline type contacts
- Fitted aluminum case



Special Price!

Order No. 52-585-310-0

Sale \$80.00

List \$185.64

Steel Squares & Sets



52-432-246-0

TOOL-A-THON
BEST SELLER!
FOWLER HIGH PRECISION

- Made of the finest carbon tool steel, these economy squares have true right angles both inside and outside
- Beams and blades ground and lapped for straightness and parallelism
- Hardened blade
- Beam grooved at inner corner for clearance of burrs and dirt
- Squareness of blade edge to the working face: 2" & 3" = ± 0.0006", 4" & 6" = ± 0.0008", 9" & 12" = ± 0.0012"

Sets come complete in a "Shop Hardened" molded case!

Blade Size	Beam Size
2"	1.5"
3"	2.5"
4"	3"
6"	4"
9"	6"
12"	8"

Order No.	Size/Description	List Price	Sale Price
: 52-432-444-0	3 Piece Square Set: 2", 4" & 6" with shop hardened case	\$73.54	\$64.00
: 52-432-246-0	4 Piece Square Set: 2", 3", 4" & 6" with shop hardened case	87.61	75.00
: 52-432-469-0	4 Piece Square Set: 4", 6", 9" & 12" with shop hardened case	172.58	150.00
: 52-432-004-0	4" Square only	23.04	19.00
: 52-432-006-0	6" Square only	25.61	22.00
: 52-432-009-0	9" Square only	58.95	50.00
: 52-432-012-0	12" Square only	110.90	91.00

Cylindrical Squares

- Used for checking squares, height gages and other instruments
- Hardened and the ends are lapped to 90° angular accuracy
- 6" cylindrical squares: ± 0.0001"
- 12" cylindrical square: ± 0.00015"
- Includes handles and wood case

52-750-012-0

52-750-006-0



Order No.	Description	List Price	Sale Price
: 52-750-006-0	6" cylindrical square	\$196.97	\$162.00
: 52-750-012-0	12" cylindrical square	281.31	235.00

Fowler®

TOOL-A-THON® Vol. 18.2



Find us on social media!



1-2-3, 2-3-4 & 2-4-6 Blocks

- 23 holes for easy clamping
- Sold in pairs
- Hardened 56 - 60 HRC
- Useful in layout & grinding work



52-439-234-0



Order No.	Description	Accuracy	List Price	Sale Price
52-439-031-0	1-2-3 Blocks	± 0.0002"/1"	\$93.33	\$62.00
52-439-234-0	NEW 2-3-4 Blocks	± 0.0001"/1"	95.00	\$5.00
52-439-246-0	2-4-6 Blocks	± 0.0003"/1"	220.22	140.00

Premium 1-2-3 Block Set

- Hardened (HRC 55 - 60)
- 23 holes for easy clamping, 5 tapped, 18 untapped thru holes
- Complete in a shop-hardened case.
- Surface finish: 6-16μ"
- Includes hex wrench and 5 mounting bolts (3/8"-16)



"Great product. Every machinist should have a set in their box" D.S.

Order No. 52-439-032-0

Sale \$72.00 List \$84.79

1/8" Parallel Set

- Parallel within 0.0008" each pair
- 6" in length x 0.125" thick
- Heights matched within ± 0.001" each pair
- Heights: 1/2", 5/8", 3/4", 7/8", 1", 1-1/8", 1-1/4", 1-3/8", 1-1/2", & 1-5/8"



Order No. 52-437-000-0

Sale \$170.00 List \$238.26

X-BLOX[®] Jr.

- Dimensions: 1-3/8" x 1-3/8" x 1-3/16"
- Reversible swing-away clamps
- Versatile clamp, plus unique offset hole pattern in top of blocks, offers a large variety of clamping possibilities
- All blocks are hardened and ground, squareness and parallelism within 0.0003"
- Set capacity: 0.030" - 1.285"
- Use mini vee to measure small, miniature or intricate parts



Order No. 52-475-001-1

Sale \$43.00

List \$54.44

Mini-Vee Combo Set

- Use this universal holding tool for small, miniature or intricate parts
- Capacity: 0.030" to 9/32"
- Furnished with bridges to straddle long workpieces, allowing top hold-down screw of V-Block clamp to be utilized
- Hardened and precision ground, square and parallel within 0.0002"
- Set contains 2 Mini-Vee Blocks, size A .030" - 5/32" cap. and size B .050" - 9/32 cap., Bridge A and B plus 5 upper prisms, 1/8", 5/32" and 3/16" cap



Order No. 52-475-110-0

Sale \$190.00

List \$217.05

X-BLOX[®] V-Block Set

2 each @:

- Dimensions: 1-1/2" L x 1-1/4" W x 1-1/4" H
- Work capacity: Approximately 1"

2 each @:

- Dimensions: 2" L x 1-1/2" W x 1-1/2" H
- Work capacity: 1-1/2"

All feature:

- Surfaces are square and parallel within 0.0005"
- V-grooves are square and parallel with all surfaces within 0.0005"
- Corresponding dimensions for each pair are alike within 0.0005"



Order No. 52-475-500-0

Sale \$118.00

List \$133.70



Fowler[®]

TOOL-A-THON[®] Vol. 18.2



Find us on social media!



Rules

52-297-006-0

EZ-Read Black Face Rules

- Hardened stainless steel
- White easy-to-read microfine graduations against a black, non-glare finish



52-330-006-0

Satin Chrome Rules

- Tempered steel
- Non-glare
- Sharp, easy-to-read microfine graduations



GRADUATIONS
4R: 8ths, 16ths, 32nds, 64ths
16R: 32nds, 64ths, 50ths, 100ths

RIGID STEEL RULES

Order No.	Finish	Size	Reading	List Price	Sale Price
52-330-006-0	Satin Chrome	6"	4R	\$14.18	\$12.00
52-337-006-0	Black	6"	4R	11.32	10.00
52-330-012-0	Satin Chrome	12"	4R	24.28	21.00
52-337-012-0	Black	12"	4R	21.83	18.00
52-350-006-0	Satin Chrome	6"	16R	11.93	10.00
52-338-006-0	Black	6"	16R	11.32	10.00
52-350-012-0	Satin Chrome	12"	16R	24.13	19.00
52-338-012-0	Black	12"	16R	19.28	15.00

FLEXIBLE STEEL RULES

Order No.	Finish	Size	Reading	List Price	Sale Price
52-295-006-0	Satin Chrome	6"	4R	\$12.14	\$10.00
52-297-006-0	Black	6"	4R	10.61	9.00
52-295-012-0	Satin Chrome	12"	4R	21.23	18.00
52-297-012-0	Black	12"	4R	17.14	15.00
52-308-006-0	Black	6"	16R	10.30	9.00
52-310-006-0	Satin Chrome	6"	16R	12.14	10.00
52-308-012-0	Black	12"	16R	17.14	15.00
52-310-012-0	Satin Chrome	12"	16R	21.52	19.00

Combination Square

- Blades are chrome plated, fully hardened and tempered
- Includes square, protractor and center head with 12" blade
- Square head has level and scriber point
- Double indexed protractor is graduated 180° in both directions
- Graduated in 8ths, 16ths, 32nds and 64ths



Order No. 52-370-012-0

Sale \$164.00

List \$208.68

Hole Gage & Hole Gage Combo

- Used for quick checking of hole diameters
- Stainless steel construction
- Combo includes 6" ruler with handy pocket clip
- Hole gage graduated in 1/16" and 0.1mm
- Hole gage 0 - 5/8" range
- Ruler graduated in 32nds and 64ths with decimal equivalents on back



52-473-010-0



52-473-015-0



NEW!

Order No.	Description	List Price	Sale Price
52-473-010-0	NEW Hole Gage	\$12.24	\$10.00
52-473-015-0	NEW Hole Gage Combo	14.28	12.00

Electronic Edge Finders

- Six equally spaced light ports provide visibility at any angle
- Made in the USA
- Edge finder lights instantly when stylus touches work edge
- Repeatability: 0.0002"
- Works on any conductive metal



54-575-600-0



54-575-625-0



54-575-650-0



Along with light indication, model #54-575-650-0 emits an audible "beep" at time of contact.

Order No.	Stylus	Shank	Audible	Battery	List Price	Sale Price
54-575-600-0	0.200"	1/2"	NO	12 volt	\$36.80	\$31.00
54-575-625-0	0.200"	1/2"	NO	12 volt	135.80	112.00
54-575-650-0	0.400"	3/4"	YES	12 volt	135.80	112.00

Carbide Super Scriber



- Lightweight • Retractable carbide tip • Knurled grip • Machined aluminum body • Pocket clip

Order No.	Description	Overall Length	List Price	Sale Price
52-500-050-0	Carbide Super Scriber	6.5"	\$34.96	\$28.00
52-500-055-0	Carbide Refill		10.71	9.00

Etching Pen



Fowler's metal etching pen is used on copper, copper alloy, stainless steel, hardened steel tools and castings, etc. Use it to initial personal tools or to restore graduations on rules, height gages, calipers, micrometers, etc. Its low-cost and disposable design offers limitless applications.

Order No. 52-730-005-0

Sale \$15.00

List \$21.42

Universal Magnetic Mini Flex Base with Zoom LED Flashlight

- Zoomable 150 lumens ultra-bright flashlight with 3 modes; bright, low and flashing
- Powerful, low-profile magnetic base
- Slim, articulating flex base allows easy and accurate positioning.
- Quick release mounting bracket clamp
- Batteries included



Order No. 52-630-451-1

Sale \$39.00

List \$53.96



Find us on social media!

QUICK CHECK *Multi-Function Check Standard*



- One compact, multi-function, precise standard
- Can be used to check and verify a multitude of measuring instruments
- Check height gages, calipers, micrometers, depth gages, bore gages, test and dial indicators, caliper gages, protractors, and more ...
- Supplied with a manufacturer's test certificate and fitted wood case
- All sizes marked are actual

Order No. 53-813-015-0

Sale \$1320.⁰⁰ List \$1644.60

SHOP-BLOX[®] Rectangular Gage Block Sets



- Manufactured to meet Federal Specification ASME B89. 1.9 - 2002 tolerances on length for inch gage blocks
- Certificate of Calibration traceable to NIST
- Tolerances to $\pm 0.00005''$
- In high-quality fitted wood case

53-672-081-0

Order No.	Description	List Price	Sale Price
53-672-036-0	36 piece Economy Rectangular Gage Block Set	\$315.37	\$210.00
53-672-081-0	81 piece Economy Rectangular Gage Block Set	539.39	390.00

TOOL-A-THON[®] Vol. 18.2
Fowler

Special Applications?

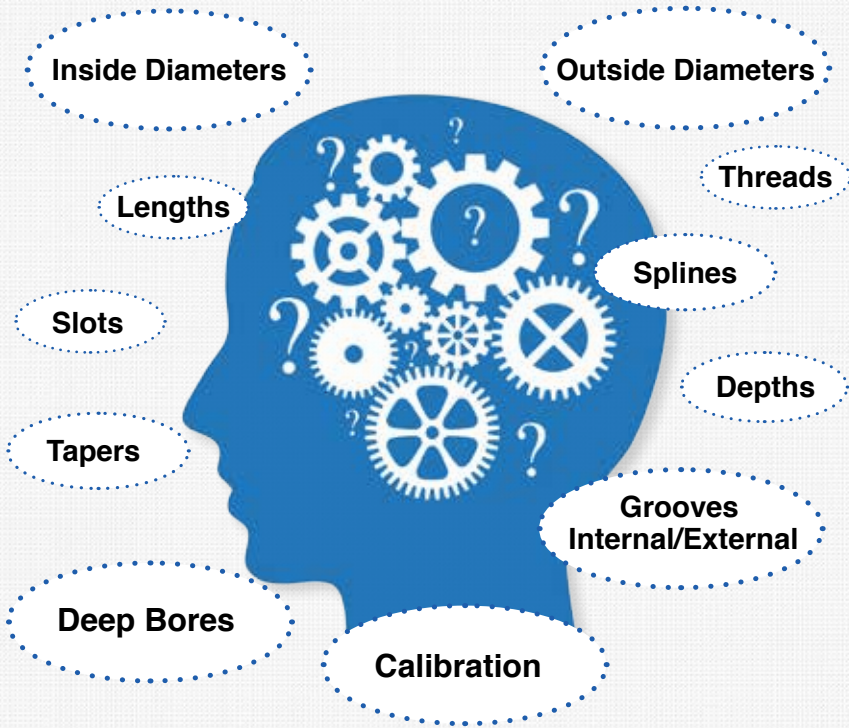

***Call our application specialist, Robert,
to solve your special application needs!
1-800-788-2353, ext. 342 • robert@fowlerprecision.com***

Trust Fowler to get the job done!

***We would love to hear feedback about
your Fowler experience!
Send your comments to davel@fowlerprecision.com***





HIGH PRECISION
www.fowlerprecision.com