

MeasurLink ENABLED
Data Management Software by Mitutoyo



FALL PROMO 2017

PRECISION TOOLS & INSTRUMENTS

Effective September 12 through December 22, 2017

FALL PROMO 2017

Complimentary Shipping on Profile Projectors

DOMESTIC U.S. ORDERS ONLY



Micrometers

QuantuMike Micrometer

4X Faster Spindle Travel

- > Faster measurement with 2mm travel per revolution instead of the standard 0.5mm.
- > A patented ratchet thimble mechanism helps ensure repeatability.
- > Function-lock system prevents inadvertent setting changes.
- > Long battery life – 2.4 years under normal operation.
- > Certificate of inspection provided.



COOLANT PROOF™

MeasurLink™ ENABLED
Data Management Software by Mitutoyo

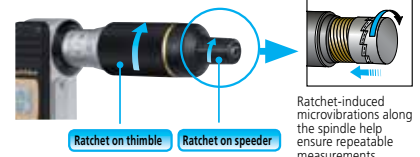

Dear Valued Customers,

I want to take a moment to express my sincere appreciation for your continued support and commitment to Mitutoyo products and services.

Inside the pages of the 2017 fall promotion, you will find a lot of great deals on a variety of Mitutoyo tools and instruments including calipers, micrometers, indicators, height gages and profile projectors. Prices are effective September 12 - December 22, 2017.

You can find all of the latest promotions, products and events on our website, www.mitutoyo.com.

Thank you for trusting us with your metrology needs.

Sincerely,

Matthew B. Dye

Matt Dye
President, Mitutoyo America Corporation

Order No.	Range	Resolution	List	Promo
293-180-30*	0-1"/0-25mm	.00005"/0.001mm	\$262.00	\$248.90
293-181-30*	1-2"/25-50mm	.00005"/0.001mm	\$300.00	\$285.00
293-185-30	0-1"/0-25mm	.00005"/0.001mm	\$226.00	\$214.70
293-186-30	1-2"/25-50mm	.00005"/0.001mm	\$258.00	\$245.10
293-182-30*	2-3"/50.8 - 76.2mm	.00005"/0.001mm	\$358.00	\$340.10
293-187-30	2-3"/50.8 - 76.2mm	.00005"/0.001mm	\$310.00	\$294.50
293-183-30*	3-4"/76.2 - 101.6mm	.00005"/0.001mm	\$385.00	\$365.75
293-188-30	3-4"/76.2 - 101.6mm	.00005"/0.001mm	\$372.00	\$353.40

*with SPC Output

SPC cable with data switch – 1m: **05CZA662** 2m: **05CZA663**

Significant reduction in positioning time

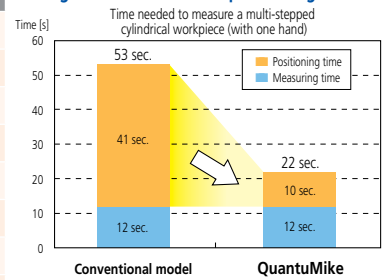

NEW Tool Kit

Tool Kit includes:

- QuantuMike **293-185-30**
- Digimatic Caliper **500-196-30**
- Mahogany Case **64PPP932**

\$368.10 Promo

\$409.00 List Price

Order No. **64PKA152**

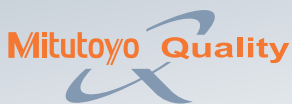

COOLANT PROOF™ IP65

COOLANT PROOF is the universal term of Mitutoyo Digimatic Small Tool Instruments that are free from measurement error and physical deterioration due to routine exposure to water, cutting oil or coolant. This high performance is achieved by using encoders that are inherently immune to contamination, where exposure is inevitable, combined with comprehensive sealing techniques and extremely oil-resistant materials to guarantee a long working life under normal operating conditions.

MDC Micrometer

- > New electromagnetic ABSOLUTE sensor - Improved resistance to environmental conditions such as dirt, oil and water, which can cause false readings.
- > New ratchet thimble on select models improves one-hand operability.
- > New anti-slip finish for improved grip while taking measurements.
- > Long battery life – 2.4 years under normal operation.
- > Fully compatible with existing Mitutoyo Digimatic peripherals (SPC Cables, U-Wave wireless transmitters, DP1-VR, etc.) – SPC output-enabled IP65 models.
- > Function-lock system prevents inadvertent setting changes.
- > Certificate of inspection provided.



www.mitutoyo.com/MDC
VIDEO DEMO

MeasurLink ENABLED
Data Management Software by Mitutoyo

COOLANT PROOF™

Order No.	Range	Resolution	Remarks	List	Promo
IP65 - With SPC Output					
293-330-30	0-1"/0-25.4mm	.00005"/0.001mm	Ratchet Stop	\$240.00	\$228.00
293-331-30	1-2"/25.4-50.8mm	.00005"/0.001mm	Ratchet Stop w/Standard	\$283.00	\$268.85
IP65 - Non-SPC Output					
293-340-30	0-1"/0-25.4mm	.00005"/0.001mm	Ratchet Stop	\$187.00	\$177.65
293-344-30	0-1"/0-25.4mm	.00005"/0.001mm	Ratchet Thimble	\$187.00	\$177.65
293-348-30	0-1"/0-25.4mm	.00005"/0.001mm	Friction Thimble	\$187.00	\$177.65
293-349-30	0-1"/0-25.4mm	.0001"/0.001mm	Ratchet Thimble	\$187.00	\$177.65
293-341-30	1-2"/25.4-50.8mm	.00005"/0.001mm	Ratchet Stop w/Standard	\$243.00	\$230.85
293-345-30	1-2"/25.4-50.8mm	.00005"/0.001mm	Ratchet Thimble w/Standard	\$243.00	\$230.85

Order No.	Description	List
05CZA662	40" SPC Cable	\$83.80
05CZA663	80" SPC Cable	\$92.45



Improved one-hand operability with ratchet thimble models



MDH Micrometer

High-Accuracy Sub-Micron Digimatic Micrometer

- > Enabling .000005"/0.1µm resolution measurement, this micrometer is ideal for customers who need to make highly accurate measurements with a handheld tool.
- > The ABS (absolute) rotary sensor eliminates the need to perform origin setting each time the power is turned on, allowing you to start measuring right away. With no possibility of overspeed errors, the high-accuracy digimatic micrometer delivers a higher level of reliability.
- > Certificate of inspection provided.

MeasurLink ENABLED
Data Management Software by Mitutoyo

Order No.	Range	Resolution	Accuracy	List	Promo
293-100	0 - 25mm	0.0001mm/ 0.0005mm (switchable)	±0.5µm	\$1,630.00	\$1,548.50
293-130	0 - 1" / 0 - 25.4mm	.000005"/.00002" 0.0001mm/0.0005mm (switchable)	±.00002"	\$1,630.00	\$1,548.50

SPC cable with data switch – 1m: 05CZA662 2m: 05CZA663



VIDEO DEMO



www.mitutoyo.com/MDH



Function lock



October 24 – 26, 2017
Donald E. Stephens Convention Center
Rosemont, IL

VISIT US AT BOOTH 1308

www.mitutoyo.com

Low Force/Adjustable Force Micrometer

Suitable for soft or hard materials

- > Constant and low measuring force mechanism in the thimble.
- > Adjustable measuring force* accommodates various types of work materials. (*0.5-2.5N or 2-10N)
- > The measurement-value hold function automatically retains the data at a specified measuring force, ensuring accuracy.
- > Non-rotating spindle and the new ratchet friction thimble.
- > Speedy spindle feed: by .4"/rev.
- > With a standard bar to set the origin point (except for 0-.6", and 0-.4" models).
- > Resolution: .00005"/0.001mm Accuracy: ±.0001"

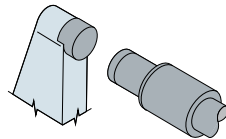

Low force models for soft materials

Order No.	Range	Measuring Force	List	Promo
227-211	0-.6"	0.5-2.5 (0.5, 1.0, 1.5, 2, 2.5) N	\$855.00	\$812.25
227-213	.6-1.2"	0.5-2.5 (0.5, 1.0, 1.5, 2, 2.5) N	\$901.00	\$855.95
227-215	0-.4"	2-10 (2, 4, 6, 8, 10) N	\$811.00	\$770.45
227-216	.4-.8"	2-10 (2, 4, 6, 8, 10) N	\$847.00	\$804.65
227-217	.8-1.2"	2-10 (2, 4, 6, 8, 10) N	\$874.00	\$830.30

SPC cable – 1m: **937387** 2m: **965013**

You Tube

Watch our videos on Specialty Calipers & Micrometers on our YouTube channel:
<http://www.mitutoyo.com/ytplaylist>

Spline Micrometer

- > The anvil and spindle have a small diameter for measuring splined shafts, slots and keyways.
- > With SPC output
- > With a standard bar except 0-1"
- > Resolution: .00005"/0.001mm

MeasurLink ENABLED
Data Management Software by Mitutoyo



Digital

Order No.	Range	Accuracy	Contacts	List	Promo
331-351-30	0 - 1" / 0 - 25.4mm	±.0001"	Ø.118"	\$470.00	\$446.50
331-361-30		±.0001"	Ø.079"	\$470.00	\$446.50
331-352-30	1 - 2" / 25.4-50.8mm	±.0001"	Ø.118"	\$527.00	\$500.65
331-362-30		±.0001"	Ø.079"	\$527.00	\$500.65
331-353-30	2 - 3" / 50.8-76.2mm	±.0001"	Ø.118"	\$571.00	\$542.45
331-363-30		±.0001"	Ø.079"	\$549.00	\$521.55
331-354-30	3 - 4" / 76.2-101.6mm	±.00015"	Ø.118"	\$661.00	\$627.95
331-364-30		±.00015"	Ø.079"	\$577.00	\$548.15

SPC cable with data switch – 1m: **05CZA662** 2m: **05CZA663**

Spherical Face Micrometer

- > Designed to measure the wall thickness of various tubing.
- > Resolution: .00005" / 0.001mm
- > With SPC output.
- > With a standard bar except 0-1" model.
- > With digital counter.



MeasurLink ENABLED
Data Management Software by Mitutoyo

Digital model with spherical anvil

Order No.	Range	Accuracy	Min ID	List	Promo
395-371-30 ^{S-S}	0 - 1" / 0 - 25.4mm	±.0001"	D: .59"	\$410.00	\$389.50
395-372-30 ^{S-S}	1" - 2" / 25.4 - 50.8mm	±.0001"	D: .59"	\$435.00	\$413.25
395-373-30 ^{S-S}	2" - 3" / 50.8-76.2mm	±.0001"	D: .75"	\$494.00	\$469.30
395-374-30 ^{S-S}	3" - 4" / 76.2-101.6mm	±.00015"	D: .79"	\$527.00	\$500.65
395-351-30 ^{S-F}	0 - 1" / 0 - 25.4mm	±.0001"	D: .59"	\$397.00	\$377.15
395-352-30 ^{S-F}	1" - 2" / 25.4 - 50.8mm	±.0001"	D: .59"	\$425.00	\$403.75
395-353-30 ^{S-F}	2" - 3" / 50.8-76.2mm	±.0001"	D: .75"	\$482.00	\$457.90
395-354-30 ^{S-F}	3" - 4" / 76.2-101.6mm	±.00015"	D: .79"	\$516.00	\$490.20

S-F: Spherical anvil and flat spindle
 S-S: Spherical anvil and spherical spindle

SPC cable with data switch – 1m: **05CZA662** 2m: **05CZA663**

Point Micrometer

- > Pointed spindle and anvil for measuring the web thickness of drills, small grooves, keyways and other hard-to-reach dimensions.
- > The measuring points have approximately 0.3mm / .012" radius.
- > With a standard bar except 0 - 1"
- > Resolution: .00005" / 0.001mm (digital models)
- > With SPC output.
- > With carbide tips

MeasurLink ENABLED
Data Management Software by Mitutoyo

IP65 **SPC**



Digital

Order No.	Range	Accuracy	Point	List	Promo
342-351-30	0 - 1" / 0 - 25.4mm	±.0001"	15°	\$462.00	\$438.90
342-361-30	0 - 1" / 0 - 25.4mm	±.0001"	30°	\$462.00	\$438.90
342-352-30	1" - 2" / 25.4 - 50.8mm	±.0001"	15°	\$515.00	\$489.25
342-362-30	1" - 2" / 25.4 - 50.8mm	±.0001"	30°	\$504.00	\$478.80
342-353-30	2" - 3" / 50.8 - 76.2mm	±.0001"	15°	\$537.00	\$510.15
342-363-30	2" - 3" / 50.8 - 76.2mm	±.0001"	30°	\$537.00	\$510.15
342-354-30	3" - 4" / 76.2 - 101.6mm	±.00015"	15°	\$571.00	\$542.45
342-364-30	3" - 4" / 76.2 - 101.6mm	±.00015"	30°	\$571.00	\$542.45

SPC cable with data switch - 1m: **05CZA662** 2m: **05CZA663**

Uni-Mike

- > Measures tubing thickness, shoulder-edge distance, rivet head height, etc. with interchangeable anvils (flat anvil, rod anvil, V-anvil).
- > IP65 water/dust protection.
- > Supplied with flat anvil (201216) and rod anvil: .118"/ø3mm dia. rod anvil (201217) for 0-1" models, .197"/ø5mm (201379) for 1-2"
- > With special optional disk anvils, the Uni-Mike can be used as a height micrometer.
- > With a standard bar except 0 - 1" model.



MeasurLink ENABLED
Data Management Software by Mitutoyo

IP65 **SPC**



Digital

Order No.	Range	Resolution	Accuracy	List	Promo
317-351-30	0 - 1" / 0 - 25.4mm	.00005" / 0.001mm	±.0002"	\$529.00	\$502.55
317-352-30	1 - 2" / 25.4 - 50.8mm	.00005" / 0.001mm	±.0002"	\$538.00	\$511.10

SPC cable with data switch - 1m: **05CZA662** 2m: **05CZA663**

Tube Micrometer

- > Used to measure the wall thickness on tubing, pipe and other hard-to-reach places. Spherical or cylindrical anvils are available.
- > IP65 water/dust protection
- > With SPC output.



Type B



Type C

Type D

MeasurLink ENABLED
Data Management Software by Mitutoyo

IP65 **SPC**

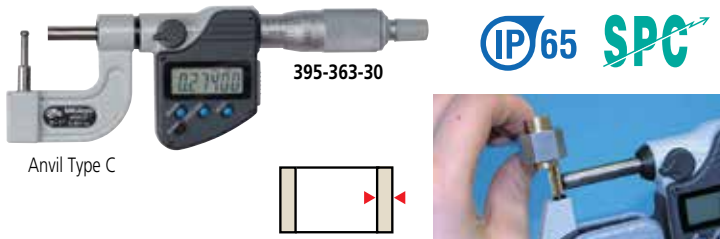

Anvil Type C

Digital

Order No.	Range	Resolution	Accuracy	Type	List	Promo
395-362-30	0 - 1" / 0 - 25.4mm	.00005" / 0.001mm	±.00015"	B	\$438.00	\$416.10
395-363-30	0 - 1" / 0 - 25.4mm	.00005" / 0.001mm	±.00015"	C	\$451.00	\$428.45
395-364-30	0 - 1" / 0 - 25.4mm	.00005" / 0.001mm	±.00015"	D	\$451.00	\$428.45

SPC cable with data switch - 1m: **05CZA662** 2m: **05CZA663**

QuickMike

- > Non-rotating spindle and the new ratchet friction thimble.
- > Speedy spindle feed: .4"/rev.
- > With absolute linear scale.
- > IP54 dust/water protection (when not connected with data output cable).
- > With SPC data output.
- > With a standard bar to set the origin point (for models with a range over 1.2").



293-676

ABSOLUTE
Absolute System Powered by MITUTOYO



293-679

MeasurLink ENABLED
Data Management Software by Mitutoyo

SPC **IP54**

Order No.	Range	Resolution	Accuracy	List	Promo
293-676	0 - 1.2" / 0 - 30.48mm	.00005" / 0.001mm	±.0001"	\$593.00	\$563.35
293-677	1" - 2.2" / 25.4 - 55.88mm	.00005" / 0.001mm	±.0001"	\$648.00	\$615.60
293-678	2" - 3.2" / 50.8 - 81.28mm	.00005" / 0.001mm	±.00015"	\$705.00	\$669.75
293-679	3" - 4.2" / 76.2 - 106.68mm	.00005" / 0.001mm	±.00015"	\$769.00	\$730.55

SPC cable - 1m: **937387** 2m: **965013**

Outside Micrometer with Interchangeable Anvils

- >Wide measuring range with interchangeable anvils.
- >Supplied with zero-setting standards bar for each range.



Order No.	Range	Resolution	List	Promo
340-351-30	0-6" / 0-152.4mm	.00005" / 0.001mm	\$732.00	\$695.40
340-352-30	6-12" / 152.4 - 304.8mm	.0001" / 0.001mm	\$900.00	\$855.00
340-720*	12-18" / 304.8 - 457.2mm	.0001" / 0.001mm	\$1,130.00	\$1,073.50
340-721*	18-24" / 457.2 - 609.6mm	.0001" / 0.001mm	\$1,280.00	\$1,216.00
340-722*	24-30" / 609.6 - 762.0mm	.0001" / 0.001mm	\$1,420.00	\$1,349.00
340-723*	30-36" / 762.0 - 914.4mm	.0001" / 0.001mm	\$1,500.00	\$1,425.00

SPC cable with data switch – 1m: **05CZA662** 2m: **05CZA663**
 * 1m: **959149** 2m: **959150**

Digimatic Micrometer

- >Wide range micrometers have an oversize frame and multiple anvils to allow a single micrometer to be used over a 6" range. This reduces tool cost for infrequently measured ranges.



Order No.	Range	Resolution	Accuracy	List	Promo
293-782	12" - 13" / 304.8 - 330.2mm	.0001" / 0.001mm	±.0003"	\$794.00	\$754.30
293-783	13" - 14" / 330.2 - 355.6mm	.0001" / 0.001mm	±.0003"	\$813.00	\$772.35
293-784	14" - 15" / 355.6 - 381.0mm	.0001" / 0.001mm	±.0003"	\$828.00	\$786.60
293-785	15" - 16" / 381.0 - 406.4mm	.0001" / 0.001mm	±.00035"	\$837.00	\$795.15
293-786	16" - 17" / 406.4 - 431.8mm	.0001" / 0.001mm	±.00035"	\$850.00	\$807.50
293-787	17" - 18" / 431.8 - 457.2mm	.0001" / 0.001mm	±.00035"	\$870.00	\$826.50
293-788	18" - 19" / 457.2 - 482.6mm	.0001" / 0.001mm	±.0004"	\$883.00	\$838.85

SPC cable with data switch – 1m: **959149** 2m: **959150**

Outside Micrometer with Extension Anvil Collars

- >2" spindle stroke.
- >Supplied with setting standards bar for each range.
- >Square and round pipes are combined for lightweight and rigid frame workpiece stopper.
- >Graduations: .001"

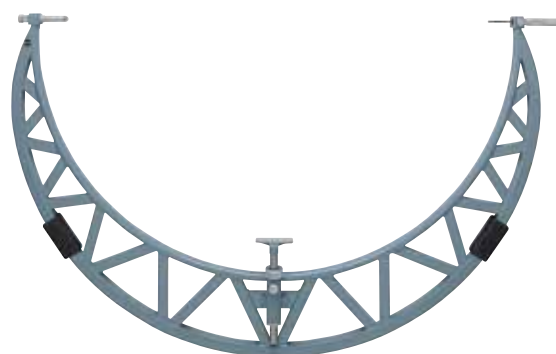

Mechanical

Order No.	Range	Extension collars	Mass (kg)	List	Promo
105-428	40 - 44"	2"	10	\$2,820.00	\$2,679.00
105-429	44 - 48"	2"	10.9	\$3,020.00	\$2,869.00
105-430	48 - 52"	2"	11.4	\$3,250.00	\$3,087.50
105-431	52 - 56"	2"	11.9	\$3,560.00	\$3,382.00
105-432	56 - 60"	2"	12.6	\$3,870.00	\$3,676.50
105-433	60 - 64"	2"	13.2	\$4,270.00	\$4,056.50
105-434	64 - 68"	2"	14.1	\$4,650.00	\$4,417.50
105-435	68 - 72"	2"	14.9	\$4,960.00	\$4,712.00
105-436	72 - 76"	2"	15.8	\$5,150.00	\$4,892.50
105-437	76 - 80"	2"	16.7	\$5,500.00	\$5,225.00

SPC Connecting Cables (optional)

Order No.	Description	List
With Data Out Switch		
05CZA662	1m — IP65 Micrometers	\$83.80
05CZA663	2m — IP65 Micrometers	\$92.45
959149	1m - Non IP Calipers, Large Micrometers	\$49.25
959150	2m - Non IP Calipers, Large Micrometers	\$55.20



05CZA662: 1m (40")
05CZA663: 2m (80")



959149: 1m (40")
959150: 2m (80")



October 24 – 26, 2017
 Donald E. Stephens Convention Center
 Rosemont, IL

VISIT US AT BOOTH 1308

ABSOLUTE Coolant-Proof Calipers

- > Sealed housing is IP-67 rated, meaning it's immune to the coolants, dirt, grit and chips found in many manufacturing environments.
- > Easy to use - no need to wipe or clean the scale.
- > .0005"/0.01mm resolution with ± 0.001 " accuracy.
- > Automatic power-on/off.
- > Certificate of inspection provided.



MeasurLink ENABLED
Data Management Software by Mitutoyo



IP67 SPC ABSOLUTE
Absolute System Patented by MITUTOYO

COOLANT PROOF™

Built-in ABS (absolute) scale means that these calipers are ready to use immediately after power-on without origin resetting. It's as easy as vernier caliper measurements.

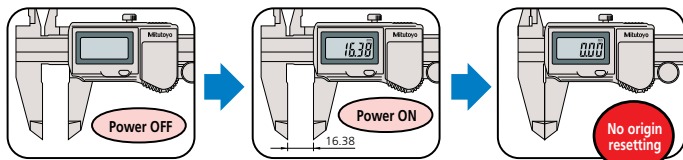

Order No.	Range	List	Promo
Non-Output Style			
500-752-20	0-6"/0-150mm	\$209.00	\$198.55
500-753-20	0-8"/0-200mm	\$280.00	\$266.00
500-754-10*	0-12"/0-300mm	\$484.00	\$459.80
SPC Output Style			
500-762-20	0-6"/0-150mm	\$248.00	\$235.60
500-763-20	0-8"/0-200mm	\$312.00	\$296.40
500-764-10*	0-12"/0-300mm	\$537.00	\$510.15

* ± 0.0015 " accuracy

SPC cable – 1m: **05CZA624** 2m: **05CZA625**

Digimatic Carbon-Fiber Caliper

- > Lightweight Digimatic Calipers that employ CFRP (Carbon Fiber Reinforced Plastics) in the beam and jaws.
- > Highly durable and easy to handle.
- > Direct readout of ID measurements from the LCD. (Offset value can be set easily by pressing the Offset key.)
- > Preset function for setting a desired starting point.
- > With SPC data output.
- > Special models available with ceramic jaws which are suitable for measuring abrasive and magnetic products.
- > Can be used in workshop conditions exposed to coolant, water, dust or oil.
- > Incorporates absolute measurement system.
- > Automatic power-on/off.



552-314-10

IP66 SPC ABSOLUTE
Absolute System Patented by MITUTOYO

Order No.	Range	Accuracy	Resolution	List	Promo
552-312-10	0(.5")-18"	± 0.002 "	.0005"/0.01mm	\$947.00	\$899.65
552-313-10	0(.5")-24"	± 0.002 "	.0005"/0.01mm	\$1,060.00	\$1,007.00
552-314-10	0(1")-40"	± 0.002 "	.0005"/0.01mm	\$1,890.00	\$1,795.50
552-315-10	0(1")-60"	± 0.004 "	.0005"/0.01mm	\$2,260.00	\$2,147.00
552-316-10	0(1")-80"	± 0.005 "	.0005"/0.01mm	\$3,540.00	\$3,363.00

SPC cable – 1m: **05CZA624** 2m: **05CZA625**

Super Caliper—Solar Powered, Coolant Proof

- > World's most unique solar-powered super caliper is eco-friendly with no battery and has IP67 protection.
- > Origin restoration unnecessary--a measurement can be started any time and with unlimited response speed.
- > No battery or origin reset needed for IP67 Digital Caliper.
- > The impact resistance of the display unit has been increased for improved usability in workshop conditions.
- > This Super Caliper uses components that do not contain harmful substances and is compatible with RoHS Directives.

MeasurLink ENABLED
Data Management Software by Mitutoyo



www.mitutoyo.com/eclipse
VIDEO DEMO

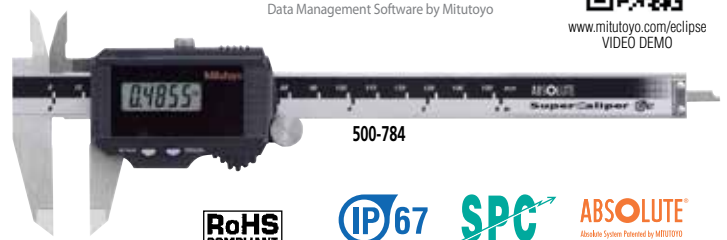

500-784

RoHS COMPLIANT IP67 SPC ABSOLUTE
Absolute System Patented by MITUTOYO

Order No.	Range	Accuracy	Resolution	List	Promo
500-786	0-6"/0-150mm	± 0.001 "	.0005"/0.01mm	\$267.00	\$253.65
500-784*	0-6"/0-150mm	± 0.001 "	.0005"/0.01mm	\$239.00	\$227.05
500-787	0-8"/0-200mm	± 0.001 "	.0005"/0.01mm	\$330.00	\$313.50
500-785*	0-8"/0-200mm	± 0.001 "	.0005"/0.01mm	\$306.00	\$290.70

*Without SPC data output

SPC cable – 1m: **05CZA624** 2m: **05CZA625**



COOLANT PROOF™ IP67

COOLANT PROOF is the universal term of Mitutoyo Digimatic Small Tool Instruments that are free from measurement error and physical deterioration due to routine exposure to water, cutting oil or coolant. This high performance is achieved by using encoders that are inherently immune to contamination, where exposure is inevitable, combined with comprehensive sealing techniques and extremely oil-resistant materials to guarantee a long working life under normal operating conditions.

ABSOLUTE Digimatic Calipers

MeasurLink ENABLED
Data Management Software by Mitutoyo

- > Electromagnetic inductive sensor improves environmental resistance against dirt, water and oil.
- > A battery life of approximately 3.5 years has been achieved under normal use through the adoption of Mitutoyo's ABSOLUTE scale.
- > The slider configuration features an ergonomic, thumb-friendly shape.
- > Step-measurement capable.
- > The data output function allows integration into statistical process control and measurement systems.
- > Display character height: 9mm
- > AOS applies to 4", 6" and 8" models
- > Resolution: .0005"/0.01mm



www.mitutoyo.com/aoscd
VIDEO DEMO



500-196-30

SPC **ABSOLUTE**
Absolute System Powered by MITUTOYO

ABSOLUTE AOS
DIGIMATIC
AOS: Advanced Onsite Sensor

Order No.	Range	Remarks	List	Promo
No SPC Output Style				
500-195-30	0-4"/0-100mm	.075" Round depth bar	\$144.00	\$136.80
500-196-30	0-6"/0-150mm		\$156.00	\$148.20
500-197-30	0-8"/0-200mm		\$224.00	\$212.80
500-193	0-12"/0-300mm		\$450.00	\$427.50
With SPC Output Style				
500-170-30	0-4"/0-100mm	.075" Round depth bar	\$172.00	\$163.40
500-171-30	0-6"/0-150mm		\$183.00	\$173.85
500-172-30	0-8"/0-200mm		\$241.00	\$228.95
500-173	0-12"/0-300mm		\$525.00	\$498.75
500-505-10	0-18"/0-450mm	Without Thumb Roller	\$819.00	\$778.05
500-506-10	0-24"/0-600mm	Without Thumb Roller	\$900.00	\$855.00
500-507-10	0-40"/0-1000mm	Without Thumb Roller	\$1,740.00	\$1,653.00

SPC cable with data switch - 1m: 959149 2m: 959150

Dial Calipers

- > Newly designed dial movement for smooth sliding and high shock protection.
- > Lock screw for dial bezel and for holding the sliding jaw position.
- > Can measure OD, ID, depth and steps.
- > Models available with carbide-tipped OD and ID jaws.

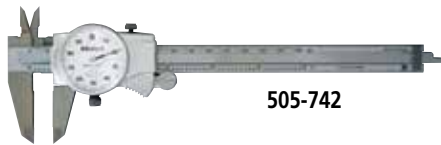

505-742

Order No.	Range	Remarks	List	Promo
505-742	6" .100"/rev.		\$121.00	\$108.90
505-738	6" .100"/rev.	Carbide-Tipped Jaws	\$207.00	\$186.30
505-740	6" .200"/rev.		\$111.00	\$99.90
505-743	8" .100"/rev		\$177.00	\$159.30
505-746	12" .100/rev		\$281.00	\$252.90
505-749	12" .200/rev		\$261.00	\$234.90

Coolant-Proof Carbon-Fiber Caliper with Interchangeable Jaws

- > The range of applications can be expanded by using interchangeable jaws (optional).
- > Quick and easy change of jaws due to the unique clamping mechanism. (A pair of clamping wheels is a standard accessory.)
- > Provided with preset function for setting a desired starting point, which allows direct readout of offset measurements.
- > Resolution: .0005"/0.01mm

IP66 **SPC** **ABSOLUTE**
Absolute System Powered by MITUTOYO

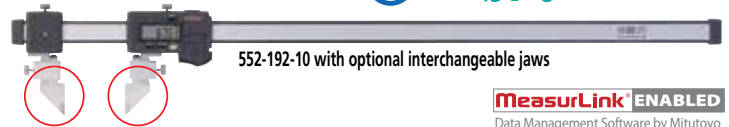

552-192-10 with optional interchangeable jaws

MeasurLink ENABLED
Data Management Software by Mitutoyo

Order No.	Range	Accuracy	List	Promo
552-191-10	0 - 18" / 0 - 450mm	±.002"	\$910.00	\$864.50
552-192-10	0 - 24" / 0 - 600mm	±.002"	\$940.00	\$893.00
552-193-10	0 - 40" / 0 - 1000mm	±.002"	\$1,510.00	\$1,434.50
552-194-10	0 - 60" / 0 - 1500mm	±.004"	\$2,450.00	\$2,327.50
552-195-10	0 - 80" / 0 - 2000mm	±.005"	\$3,430.00	\$3,258.50

SPC cable with data switch - 1m: 05CZA624 2m: 05CZA625

Interchangeable Jaws (optional)

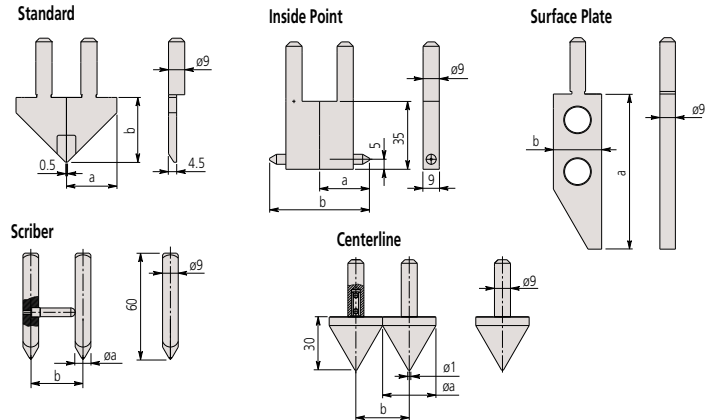

Order No.	Components	a	b	List	Promo
Standard					
07CZA056	Right (07CAA044), Left (07CAA045)	28mm (1.1")	30mm (1.2")	\$308.00	\$292.60
Inside Point					
07CZA058	07CZA041 x 2pcs.	25mm	50mm	\$317.00	\$301.15
07CZA059	07CZA048 x 2pcs.	1"	2"	\$342.00	\$324.90
Scriber					
07CZA055	Right (07CZA042), Left (07CZA043)	8mm	30mm	\$335.00	\$318.25
07CZA061	Right (07CZA042), Left (07CZA049)	.31"	1.2"	\$342.00	\$324.90
Surface Plate					
07CZA044		3.5" / 90mm	1.1" / 28mm	\$267.00	\$253.65
Centerline					
07CZA057	07CZA039 x 2pcs.	30mm	30mm	\$342.00	\$324.90
07CZA060	07CZA047 x 2pcs.	1.2"	1.2"	\$317.00	\$301.15

Offset Caliper

- Main scale jaw can slide up and down to facilitate measurement of stepped sections. (Hard-to-reach dimensions such as A, B, C can be accurately measured.)
- With depth bar.
- With SPC data output.

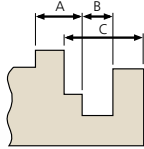

Order No.	Range	Accuracy	Resolution	List	Promo
573-701-20	0 - 6" / 0 - 150mm	±.001"	.0005" / 0.01mm	\$464.00	\$440.80
573-702-20	0 - 8" / 0 - 200mm	±.001"	.0005" / 0.01mm	\$532.00	\$505.40
573-704	0 - 12" / 0 - 300mm	±.0015"	.0005" / 0.01mm	\$714.00	\$678.30

SPC cable with data switch – 1m: **05CZA624** 2m: **05CZA625**

Point Caliper

- Narrow tip jaws fit into very small grooves and tracks, making many previously difficult outside measurements easier to obtain.
- With depth bar.
- With SPC data output.

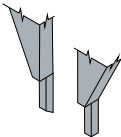

Order No.	Range	Accuracy	Resolution	List	Promo
573-721-20	0 - 6" / 0 - 150mm	±.001"	.0005" / 0.01mm	\$407.00	\$386.65
573-725-20*	0 - 6" / 0 - 150mm	±.001"	.0005" / 0.01mm	\$505.00	\$479.75

* Extended tips

SPC cable with data switch – 1m: **05CZA624** 2m: **05CZA625**

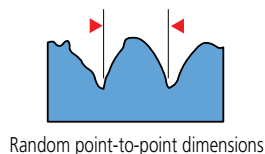

Random point-to-point dimensions

Neck Caliper

- Point-jaw type can measure wall thickness inside bores and recesses.
- Flat-jaw type can measure grooves and recesses.
- With SPC data output.

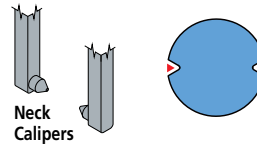
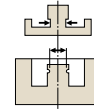

Order No.	Range	Accuracy	Resolution	List	Promo
573-751	0 - 6" / 0 - 150mm	±.0015"	.0005" / 0.01mm	\$667.00	\$633.65
573-752-20*	0 - 6" / 0 - 150mm	±.0015"	.0005" / 0.01mm	\$802.00	\$761.90

*Point jaw

SPC cable with data switch – 1m: **05CZA624** 2m: **05CZA625**

Low-Force Caliper

- Due to the low measuring force these calipers are ideal for elastic or resilient workpieces such as plastic parts and rubber parts that standard calipers can't measure consistently.
- With SPC data output.



Measurement procedures



To measure resilient workpieces, take the measurement when the pointer is between the two index lines.

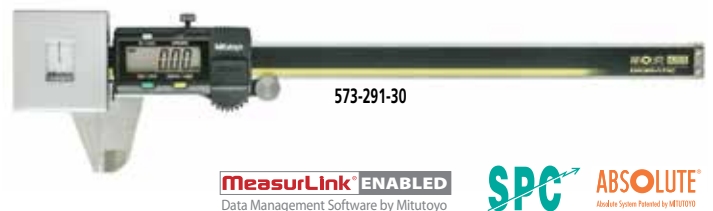

Order No.	Range	Accuracy	Resolution	List	Promo
573-291-30	0 - 7" / 0 - 180mm	±.002"	.0005" / 0.01mm	\$820.00	\$779.00

SPC cable with data switch – 1m: **959149** 2m: **959150**

Digimatic Caliper with Nib-Style Jaws

- > The rounded faces of the jaws are ideal for accurate ID (inside diameter) measurement.
- > With SPC output.



MeasurLink ENABLED
Data Management Software by Mitutoyo

IP67 **SPC** **ABSOLUTE**
Absolute System Powered by MI01010

SPC cable with data switch – 1m: **05CZA624** 2m: **05CZA625**

Order No.	Range*	Accuracy	Resolution	List	Promo
550-311-20	0 (.4") - 8" / 0 (10) - 200mm	±.001"	.0005" / 0.01mm	\$525.00	\$498.75
550-341-10	0 (.4") - 12" / 0 (10) - 300mm	±.0015"	.0005" / 0.01mm	\$763.00	\$724.85
550-223-10**	0 (.5") - 18" / 0 (20) - 450mm	±.002"	.0005" / 0.01mm	\$956.00	\$908.20
550-225-10**	0 (.5") - 24" / 0 (20) - 600mm	±.002"	.0005" / 0.01mm	\$1,070.00	\$1,016.50
550-227-10**	0 (1") - 40" / 0 (20) - 1000mm	±.003"	.0005" / 0.01mm	\$1,910.00	\$1,814.50

* () : Minimum dimension in ID measurement **Models are not IP67 rated

Digimatic Caliper with Nib and Standard Jaws

- > The rounded faces of the jaws are ideal for accurate ID (inside diameter) measurement.
- > With SPC output.

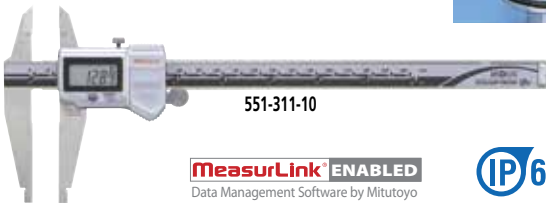

MeasurLink ENABLED
Data Management Software by Mitutoyo

IP67 **SPC**

Order No.	Range*	Accuracy	Resolution	List	Promo
551-311-10	0 (.4") - 8" / 0 (10) - 200mm	±.001"	.0005" / 0.01mm	\$579.00	\$550.05
551-341-10	0 (.4") - 12" / 0 (10) - 300mm	±.002"	.0005" / 0.01mm	\$829.00	\$787.55
551-224-10**	0 (.5") - 20" / 0 (20) - 500mm	±.0025"	.0005" / 0.01mm	\$1,220.00	\$1,159.00
551-226-10**	0 (.5") - 30" / 0 (20) - 750mm	±.0025"	.0005" / 0.01mm	\$1,980.00	\$1,881.00
551-227-10**	0 (1") - 40" / 0 (20) - 1000mm	±.003"	.0005" / 0.01mm	\$2,080.00	\$1,976.00

* () : Minimum dimension in ID measurement
** Models are not IP67 rated

SPC cable with data switch – 1m: **05CZA624** 2m: **05CZA625**

Inside Caliper Knife-Edge/Inside Groove/Point Jaw

- > Special ID jaw calipers are designed for difficult-to-measure areas, such as ID grooves or recessed areas.
- > With SPC data output.



IP67 **SPC** **ABSOLUTE**
Absolute System Powered by MI01010

Knife edge



Measurable min. hole diameter: ϕ .4"

MeasurLink ENABLED
Data Management Software by Mitutoyo

Inside groove



Measurable min. hole diameter: ϕ .4"

MeasurLink ENABLED
Data Management Software by Mitutoyo

Point jaw



Measurable min. hole diameter: ϕ .8"

MeasurLink ENABLED
Data Management Software by Mitutoyo

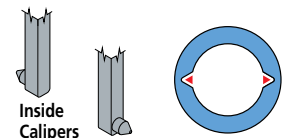

Order No.	Range	Accuracy	List	Promo
573-742-20	.4" - 8" / 10-200mm	±.002"	\$910.00	\$864.50
573-745-20	.4" - 6" / 10-150mm	±.002"	\$727.00	\$690.65
573-746	.8" - 6" / 20-150mm	±.0015"	\$883.00	\$838.85

SPC cable with data switch – 1m: **05CZA624** 2m: **05CZA625**

ABSOLUTE Digimatic Indicator ID-S

- > Employing the ABSOLUTE linear encoder, the ID-S always displays the spindle Absolute Position from the origin at power-on. Also unlimited response speed eliminates overspeed errors.
- > Dust/Water protection level: IP42 (IP53: **543-794B, 543-795B, 543-796B**)
- > SPC data output.



MeasurLink ENABLED
Data Management Software by Mitutoyo



Order No.	Resolution	Range	Accuracy	Measuring force	Remarks	List	Promo
Stem dia. 3/8, #4-48 UNF Thread							
543-792	.00005"/0.001mm	.5" / 12.7mm	±.0001"	1.5N or less	w/ lug back	\$273.00	\$259.00
543-796	.00005"/0.001mm	.5" / 12.7mm	±.0001"	2.5N or less	w/ lug back	\$301.00	\$285.00
543-793	.0001"/0.001mm	.5" / 12.7mm	±.0001"	1.5N or less	w/ lug back	\$273.00	\$260.00
543-783	.0005"/0.01mm	.5" / 12.7mm	±.0010"	1.5N or less	w/ lug back	\$177.00	\$168.00
543-792B	.00005"/0.001mm	.5" / 12.7mm	±.0001"	1.5N or less	w/ flat-back	\$273.00	\$259.00
543-796B	.00005"/0.001mm	.5" / 12.7mm	±.0001"	2.5N or less	w/ flat-back	\$301.00	\$286.00
543-793B	.0001"/0.001mm	.5" / 12.7mm	±.0001"	1.5N or less	w/ flat-back	\$273.00	\$259.00
543-783B	.0005"/0.01mm	.5" / 12.7mm	±.0010"	1.5N or less	w/ flat-back	\$177.00	\$168.00
Stem ø 8mm, M2.5 x 0.45 Thread							
543-791	.00005"/0.001mm	.5" / 12.7mm	±.0001"	1.5N or less	w/ lug back	\$282.00	\$268.00
543-795	.00005"/0.001mm	.5" / 12.7mm	±.0001"	2.5N or less	w/ lug back	\$310.00	\$295.00
543-782	.0005"/0.01mm	.5" / 12.7mm	±.0008"	1.5N or less	w/ lug back	\$177.00	\$168.00
543-791B	.00005"/0.001mm	.5" / 12.7mm	±.0001"	1.5N or less	w/ flat-back	\$282.00	\$268.00
543-795B	.00005"/0.001mm	.5" / 12.7mm	±.0001"	2.5N or less	w/ flat-back	\$310.00	\$295.00
543-782B	.0005"/0.01mm	.5" / 12.7mm	±.0008"	1.5N or less	w/ flat-back	\$177.00	\$168.00

SPC cable with data switch – 1m: 905338 2m: 905409

IDC Digimatic Indicators

- > Absolute Encoder ensures all settings and readings maintained for the life of the battery (even when the power is turned off).
- > Preset, zero set, inch/mm, +/- direction and go/no-go functions.
- > Face rotates 330° for use at various angles.
- > Stem diameter: .375"
- > Immune to overspeed error.
- > SPC output provided.
- > Average battery life 7,000 hours using SR-44 battery (541980).

MeasurLink ENABLED
Data Management Software by Mitutoyo



*Models available with selectable resolutions: .00005"/.0001"/.0005"/0.001mm/0.01mm

Now with multiplier function $f(x)=Ax$ (other models available with $Ax+B+Cx-1$ function; contact Mitutoyo)

Order No.	Range	Remarks	List	Promo
.0005"/0.01mm Resolution				
543-402	.500"/12.7mm	Lug Back	\$310.00	\$294.50
543-402B	.500"/12.7mm	Flat Back	\$310.00	\$294.50
543-476B	1"/25mm	Flat Back	\$454.00	\$431.30
543-496B	2"/50mm	Flat Back	\$597.00	\$567.15
.00005"/.0001"/.0005"/0.001mm/0.01mm Resolution*				
543-392	.500"/12.7mm	Lug Back	\$424.00	\$402.80
543-392B	.500"/12.7mm	Flat Back	\$424.00	\$402.80
543-472B	1"/25mm	Flat Back	\$568.00	\$539.60
543-492B	2"/50mm	Flat Back	\$713.00	\$677.35

SPC cable with data switch – 1m: 905338 2m: 905409

www.mitutoyo.com

Digimatic Indicator ID-H

Remote programming capable

- > This digital indicator offers the excellent accuracy and functionality expected from this class of indicator. Take advantage of its high accuracy backed up by 0.5µm / .00002" resolution, remote control functionality via a handheld controller (or an RS-232C interface) and easy runout measurements with the well-established analog bar display.
- > The maximum, minimum or runout value can be displayed during measurement.
- > Go/no-go judgment is performed by setting the upper and lower tolerances. If a judgment result is out of tolerance, the display backlighting changes from green to red, so tolerance judgment can be made at a glance.
- > With RS-232C input/output

Stem dia. 3/8" #4-48 UNF Thread

Order No.	Resolution	Range	Model	Accuracy	List	Promo
543-562A	.00002", .00005", .0001", 0.0005mm,	1.2" / 30.4mm	ID-H530E	0.0015mm	\$883.00	\$794.70
543-564A	0.001mm	2.4" / 60.9mm	ID-H560E	0.0025mm	\$1,050.00	\$945.00

SPC cable with data switch – 1m: 936937 2m: 965014

21EZA099
Remote controller
(optional)



543-564A



MeasurLink ENABLED
Data Management Software by Mitutoyo

ABSOLUTE Digimatic Indicator ID-F

- > With the ABSOLUTE linear encoder technology, once the measurement reference point has been preset, it will not be lost when the power is turned on.
- > Go/no-go judgment is performed by setting the upper and lower tolerances. If a judgment result is out of tolerance, the display backlighting changes from green to red, so tolerance judgment can be made at a glance.
- > The maximum, minimum or runout value can be displayed during measurement.
- > An analog bar indicator has been integrated to handle upper/lower limit approaching and zero approaching. It enhances the ease of operation in the same manner as a dial indicator. The display range of the analog bar can be changed.



Stem dia. 3/8" #4-48 UNF Thread

Order No.	Resolution	Range	Model	Accuracy	List	Promo
543-552A	.00005", .0001", .0005", .001", 0.001mm,	1" / 25.4mm	ID-F125E	.00012"	\$667.00	\$600.30
543-558A	0.01mm	2" / 50.8mm	ID-F150HE	.00012"	\$773.00	\$695.70

SPC cable with data switch – 1m: 936937 2m: 965014



543-552A



543-558A



MeasurLink ENABLED
Data Management Software by Mitutoyo

ABSOLUTE Digimatic Indicator ID-U

- > Slim digital indicator with low price.
- > Large LCD and simple key operation.
- > After the initial origin setting, the ID-U no longer needs absolute positioning over the entire battery life; the origin is remembered even after power-off.
- > Ideal for installation into measuring devices because of compact design and long battery life.
- > Employing the ABSOLUTE linear encoder, the ID-U always displays the spindle Absolute Position from the origin at power-on. Also unlimited response speed eliminates overspeed errors.
- > Flat-back type has no option for backs.

Order No.	Resolution	Range	Model	Accuracy	Measuring force	List	Promo
575-123	.0005"/0.01mm	1" / 25.4mm	ID-U1025E	.0008"	1.8N or less	\$195.00	\$175.50

SPC cable with data switch – 1m: 936937 2m: 965014



575-123



MeasurLink ENABLED
Data Management Software by Mitutoyo

Calculation-Type Digimatic Indicator ID-C

- > Calculation-Type Digimatic Indicator features both a key lock and parameter lock.
- > Improved parameter setting software makes it even easier to set all of the available parameters and determine and upload the proper coefficients for calculation. (optional)
- > Fast measurement frequency up to 50 per second.
- > An analog bar provides easy-to-read values when scanning for Max, Min and TIR Values.
- > The Absolute Digimatic indicator performs internal calculations using the formula $Ax+B+Cx-1$ (assuming spindle displacement as x), while the specified coefficients

A, B and C can be set with respect to the purpose of measurement or dimensions of the fixtures. This unique feature allows for reading measurements directly, without fumbling for conversions.



MeasurLink ENABLED
Data Management Software by Mitutoyo



www.mitutoyo.com/dccal
VIDEO DEMO



Stem dia. 3/8" #4-48 UNF Thread

Order No.	Resolution	Range	Accuracy	Measuring Force	List	Promo
543-342B	0.0005"/0.001"/0.005" (0.001/0.01mm)	.5"/12.7mm	±.00010"/0.003mm	1.5N or less	\$445.00	\$400.50
543-592B	Selectable	1"/25.4mm	±.00010"/0.003mm	1.8N or less	\$596.00	\$536.40
543-597B	Selectable	2"/50.8mm	±.00025"/0.006mm	2.3N or less	\$748.00	\$673.20

SPC cable with data switch – 1m: **905338** 2m: **905409**



ABSOLUTE

Bore Gage ABSOLUTE Digimatic Indicator ID-C

- > Bore Gage Digimatic Indicator features both a key lock and parameter lock.
- > Fast measurement frequency up to 50 per second.
- > The minimum value holding function provides easy detection of hole diameter.
- > An analog bar indicator is integrated to enhance the intuition in reading.
- > Up to three sets of master values and upper/lower tolerance values can be memorized.

- > Go/no-go judgment
- > Employing the ABSOLUTE linear encoder, the ID-C always displays the spindle Absolute Position from the origin at power-on.
- > Improved parameter setting software makes it even easier to set all of the available parameters and determine and upload the proper coefficients for calculation. (optional)

Installed on optional bore gage probe (page 14)



Order No.	Resolution	Range	Accuracy	Measuring Force	List	Promo
543-312B	0.0005"/0.001"/0.005" (0.001/0.01mm) Selectable	.5"/12.7mm	±.00010"/0.003mm	1.5N or less	\$445.00	\$400.50

SPC cable with data switch – 1m: **905338** 2m: **905409**

MeasurLink ENABLED
Data Management Software by Mitutoyo



ABSOLUTE

Peak Hold ABSOLUTE Digimatic Indicator ID-C

With Max./Min. Value Holding Function

- > Peak Hold Digimatic Indicator features both a Key Lock and Parameter Lock.
- > An analog bar provides easy-to-read values when scanning for Max, Min and TIR Values.
- > Go/no-go judgment
- > The maximum, minimum or runout value can be displayed during measurement.

- > High speed sampling ratio of 50 times/s.
- > Employing the ABSOLUTE linear encoder, the Signal ID-C always displays the spindle Absolute Position from the origin at power-on.
- > Improved parameter setting software makes it even easier to set all of the available parameters and determine and upload the proper coefficients for calculation. (optional)

MeasurLink ENABLED
Data Management Software by Mitutoyo



Order No.	Resolution	Range	Accuracy	Remarks	List	Promo
Stem dia. 3/8, #4-48 UNF Thread						
543-302	.00005"/0.001"/0.005" 0.001/0.01mm	.5"/12.7mm	±.00010"/0.003mm	w/lug	\$445.00	\$400.50
543-302B	Selectable	.5"/12.7mm	±.00010"/0.003mm	Flat-back	\$445.00	\$400.50

SPC cable with data switch – 1m: **905338** 2m: **905409**



ABSOLUTE

www.mitutoyo.com

Bore Gages

- Carbide-tipped contact points for durability.
- The dial indicator is fully protected by a rugged cover.
- Optional extension rods can be attached for measuring deep holes.

See digimatic indicators for bore gages (page 13)



Optional Accessories

- 953549:** 125mm / 4.92" Extension rod for 18-35mm / .7 - 1.4" models
- 953552:** 125mm / 4.92" Extension rod for 35-160mm / 1.4 - 6.5" models
- 953557:** 125mm / 4.92" Extension rod for 160-400mm / 6.5 - 16" models
- 953550:** 250mm / 9.84" Extension rod for 18-35mm / .7 - 1.4" models
- 953553:** 250mm / 9.84" Extension rod for 35-160mm / 1.4 - 6.5" models
- 952361:** 250mm / 9.84" Extension rod for 160-400mm / 6.5 - 16" models
- 953551:** 500mm / 19.69" Extension rod for 18-35mm / .7 - 1.4" models
- 953554:** 500mm / 19.69" Extension rod for 35-160mm / 1.4 - 6.5" models
- 953558:** 500mm / 19.69" Extension rod for 160-400mm / 6.5 - 16" models
- 953555:** 750mm / 29.53" Extension rod for 35-160mm / 1.4 - 6.5" models
- 953559:** 750mm / 29.53" Extension rod for 160-400mm / 6.5 - 16" models
- 953556:** 1000mm / 39.37" Extension rod for 35-160mm / 1.4 - 6.5" models
- 953560:** 1000mm / 39.37" Extension rod for 160-400mm / 6.5 - 16" models



511-751

Order No	Range	Graduation (Indicator)	Anvils	Spacers	List	Promo
511-751	.7 - 1.4"	.0001" (2923SB-10)	9	2	\$411.00	\$369.90
511-752	1.4 - 2.5"		6	4	\$401.00	\$360.90
511-753	2.0 - 6.0"		11 (2" sub anvil)	4	\$438.00	\$394.20
511-754	4.0 - 6.5"		13	4	\$579.00	\$521.10
511-755	6.5 - 10"		6	7	\$652.00	\$586.80
511-756	10 - 16"		5 (3" sub anvil)	7	\$776.00	\$698.40

Digimatic Holtest

- TiN-coated measuring contact points provide excellent durability and impact resistance and allow the instrument to measure close to the bottom of blind holes (up to 100mm / 4" models).
- Large LCD readout.
- Functions available: Presetting, Zero/ABS, Auto power On/Off, Data hold, Data output, Error alarm, Battery replacement alarm.
- With ratchet stop for constant force.
- Measure deep holes by attaching an extension rod (optional).
- Setting rings are included in sets, but optional for individual gages.
- Supplied in fitted plastic case up to 100mm / 4". Over 100mm / 4" supplied in wooden case.
- Resolution: .00005"/0.001mm (over 4" models: .0001"/0.001mm)

SAVE 20%

MeasurLink ENABLED
Data Management Software by Mitutoyo



468-263



468-274



www.mitutoyo.com/dholtest
VIDEO DEMO



Order No	Range	Accuracy	List	Promo
468-261	.275 - .35" / 6.925 - 8.89mm	±.0001"	\$1,110.00	\$888.00
468-262	.35 - .425" / 8.89 - 10.795mm	±.0001"	\$1,110.00	\$888.00
468-263	.425 - .5" / 10.795 - 12.7mm	±.0001"	\$1,120.00	\$896.00
468-264	.5 - .65" / 12.7 - 16.51mm	±.0001"	\$1,220.00	\$976.00
468-265	.65 - .8" / 16.51 - 20.32mm	±.0001"	\$1,220.00	\$976.00
468-266	.8 - 1" / 20.32 - 25.4mm	±.00015"	\$1,250.00	\$1,000.00
468-267	1 - 1.2" / 25.4 - 30.48mm	±.00015"	\$1,250.00	\$1,000.00
468-268	1.2 - 1.6" / 30.48 - 40.64mm	±.00015"	\$1,280.00	\$1,024.00
468-269	1.6 - 2" / 40.64 - 50.8mm	±.00015"	\$1,290.00	\$1,032.00
468-270	2 - 2.5" / 50.8 - 63.5mm	±.00015"	\$1,400.00	\$1,120.00
468-271	2.5 - 3" / 63.5 - 76.2mm	±.00015"	\$1,400.00	\$1,120.00
468-272	3 - 3.5" / 76.2 - 88.9mm	±.00015"	\$1,420.00	\$1,136.00
468-273	3.5 - 4" / 88.9 - 101.6mm	±.00015"	\$1,440.00	\$1,152.00
468-274	4 - 5" / 101.6 - 127mm	±.00025"	\$1,880.00	\$1,504.00

Optional Accessories

- 04AZB157:** Mounting plate for stand
- 156-101-10:** Stand
- 952322:** Extension rod 100mm / 3.94"
For range 6-12mm / .275 - .5" models
- 952621:** Extension rod 150mm / 5.9"
For range 12-20mm / .5" - .8" models
- 952622:** Extension rod 150mm / 5.9"
For range 20-50mm / .8" - 2" models
- 952623:** Extension rod 150mm / 5.9"
For range 50-300mm / 2" - 12" models

Ultra-High Accuracy

Laser Scan Micrometer LSM-902/6900

- > High-accuracy inspection of pin and plug gages and other tight-tolerance parts such as medical and aerospace.
- > Ultra-high accuracy: Linearity of $\pm 0.5\mu\text{m}$ for entire range.
- > Statistical calculation mode.
- > Ultra-high repeatability of $\pm 0.05\mu\text{m}$.
- > RS-232C output, I/O interface are standard.

MeasurLink⁺ ENABLED
Data Management Software by Mitutoyo



544-496A

Bench Top

Laser Scan Micrometer LSM-9506

- > Integrated display and measuring unit into one unit.
- > Statistical calculation mode.
- > RS-232C output, I/O interface, and SPC output interface are standard.

MeasurLink⁺ ENABLED
Data Management Software by Mitutoyo



544-116-1A

Order Number	Range	Resolution	List	Promo
544-496A	.004" - 1.0"/0.1mm - 25mm	.000001" - .0005"/0.00001 - 0.01mm	\$12,200.00	\$10,980.00
544-116-1A	.020" - 2.36"/0.5mm - 60mm	.000002" - .005"/0.00005 - 0.1mm	\$8,940.00	\$8,046.00

QUICKTOOL* is free downloadable software that makes programming the LSM-6200 quick and easy.
*For use with customer-supplied PC and optional RS-232C cable.



www.mitutoyo.com/LSM
VIDEO DEMO

High-Accuracy Non-Contact Measuring Systems

- > Excellent linearity: down to ± 0.3 micron.
- > High-speed scanning capable: 3,200 scans per second.
- > Various ranges available for selecting the best laser for your application.
- > Statistical calculation mode.
- > Memory function has been increased to allow storage of up to 100 programs.

MeasurLink⁺ ENABLED
Data Management Software by Mitutoyo

QUICKTOOL* is free downloadable software that makes programming the LSM-6200 quick and easy.
*For use with customer-supplied PC and optional RS-232C cable.



LSM-6200 Display Unit Included

Order No	Model	Range Inch	Range mm	Repeatability	Linearity	Scanning Rate	List	Promo
64PKA117	LSM-500S	.0002" - .08"	0.005~2mm	$\pm 0.03\mu\text{m}$	$\pm 0.3\mu\text{m}$	3,200 scans/sec	\$10,370.00	\$7,090.00
64PKA118	LSM-501S	.002" - .4"	0.05~10mm	$\pm 0.04\mu\text{m}$	$\pm 0.5\mu\text{m}^{\dagger}$	3,200 scans/sec	\$9,330.00	\$6,050.00
64PKA119	LSM-503S	.012" - 1.18"	0.3~30mm	$\pm 0.11\mu\text{m}$	$\pm 1.0\mu\text{m}^{\dagger}$	3,200 scans/sec	\$10,110.00	\$6,830.00
64PKA120	LSM-506S	.04" - 2.36"	1~60mm	$\pm 0.36\mu\text{m}$	$\pm 3\mu\text{m}^{\dagger}$	3,200 scans/sec	\$11,480.00	\$8,200.00
64PKA121	LSM-512S	.04" - 4.72"	1~120mm	$\pm 0.85\mu\text{m}$	$\pm 6\mu\text{m}^{\dagger}$	3,200 scans/sec	\$17,680.00	\$14,400.00
64PKA122	LSM-516S	.04" - 6.30"	1~160mm	$\pm 1.4\mu\text{m}$	$\pm 7\mu\text{m}^{\dagger}$	3,200 scans/sec	\$28,480.00	\$25,200.00

[†] Linearity over entire range. Higher accuracies are possible over smaller ranges.

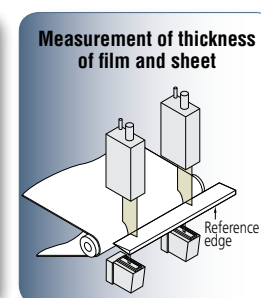
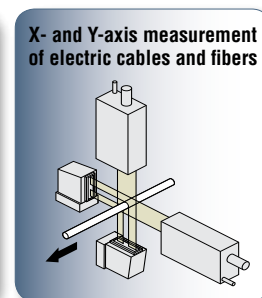
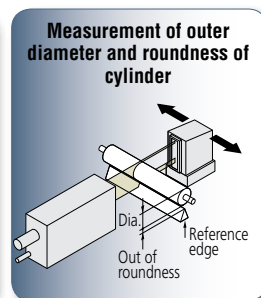
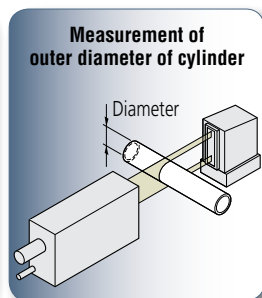
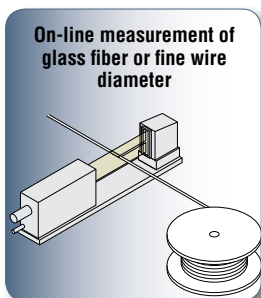

Linear Height LH-600E

The Mitutoyo Linear Height LH-600E offers advanced performance for reliable and easy 2D measurement.

Measuring Range (stroke) 0–38" (24") / 0–972mm(600mm)

- > Excellent accuracy of $(1.1+0.6L/600)\mu\text{m}$ with $0.1\mu\text{m}/0.5\mu\text{m}$ resolution/repeatability.
- > Perpendicularity (frontal) of $5\mu\text{m}$ and straightness of $4\mu\text{m}$ are guaranteed.
- > Pneumatic full/semi-floating system allows adjustment of air-cushion height.
- > One-key operation for running a semi-automatic measurement.
- > Data entry from a Digimatic tool.



Order No.	Description	List	Promo
518-351A-21	LH-600E	\$8,480.00	\$8,056.00
518-352A-21	LH-600EG with power grip	\$8,990.00	\$8,540.00



5.7" color LCD



With power grip



VIDEO DEMO

QM-Height High-Precision ABSOLUTE Digital Height Gage

- > High-accuracy / high-resolution ABSOLUTE linear encoder for position detection
- > High-accuracy – $\pm(2.4 + 2.1L / 600)\mu\text{m}$
- > Pneumatic flotation system / positioning grip – allows for smooth movement along surface plate (select models)
- > Large, stationary display panel with user-friendly icon control keys and go/no-go LED indicator
- > Digital and USB output – Supports Mitutoyo wireless SPC output
- > Long battery life with standard AA batteries (4) – Up to 300 hours (80 hours with regular use of pneumatic flotation function)
- > Fully compatible with existing Mitutoyo Digimatic peripherals (SPC cables, U-Wave wireless transmitters, multiplexers, etc.)

Go/ \pm NG judgment by LED (red, orange, green) and measurement examples

- > LEDs are activated at the time of tolerance judgment – green for Go, red for +NG, and orange for -NG. -NG, GO and +NG also appear on the LCD.



Order No.	Range	Resolution	Remarks	List	Promo
64PKA094A	0 - 14" / 0 - 350mm	0.001mm / 0.0005mm /.00005" / .0001"		\$3,990.00	\$3,591.00
64PKA095A	0 - 24" / 0 - 600mm			\$4,490.00	\$4,041.00
64PKA129A	0 - 14" / 0 - 350mm		Pneumatic Flotation System	\$4,490.00	\$4,041.00
64PKA130A	0 - 24" / 0 - 600mm			\$4,990.00	\$4,491.00



Inside diameter measurement

Digimatic Height Gages (Multi-Function)

Now with two resolutions (.0002"/.0005"), two-value preset memory and increased character height for easier viewing.

- › Highly versatile, multi-function type.
- › Carbide-tipped long scriber is provided.
- › Rigid construction ensures repeatable measurement.
- › Switchable resolution.
- › Coarse/fine feed switching.
- › With SPC data output.
- › Two preset reference heights.
- › Inclined handle improves slider ergonomics.
- › Zero/ABS setting (ABS and INC modes)
- › Two-value preset memory
- › Data/hold
- › ± Counting
- › Inch/mm conversion

MeasurLink ENABLED
Data Management Software by Mitutoyo



192-670-10

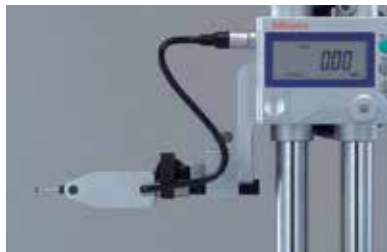

Shown with optional touch-signal probe



Dial Height Gages

Double-column structure ensures high measuring accuracy. Coarse/fine feed switching. Carbide-tipped scriber.

- › Easy and error-free reading with both up and down digital counters, as well as a dial.
- › Provided with a feed wheel for easy coarse feeding.
- › Carbide-tipped scriber is provided.
- › The counters and dial can be re-zeroed at any scriber position.
- › Fits comfortably in the hand and moves easily on the surface plate.



Comfortable grip base



Easy and secure clamping



Easy and error-free reading



192-150

Order No.	Range	Resolution	Accuracy	List	Promo
192-670-10	0-12"/0-300mm	.0005"(0.01mm)	±001"	\$1,770.00	\$1,681.50
192-671-10	0-18"/0-450mm	[.0002"(0.005mm)	±0015"	\$2,280.00	\$2,166.00
192-672-10	0-24"/0-600mm	Switchable]	±0015"	\$2,920.00	\$2,774.00

Order No.	Range	Graduation	List	Promo
192-150	0-12"	.001"	\$1,010.00	\$959.50
192-151	0-18"	.001"	\$1,400.00	\$1,330.00
192-152	0 - 24"	.001"	\$1,820.00	\$1,729.00



October 24 – 26, 2017
Donald E. Stephens Convention Center
Rosemont, IL

VISIT US AT BOOTH 1308

Durometers (Digital and Analog) For Rubber and Plastics Hardness Testing

> Durometers are suitable for testing natural rubber, neoprene, polyesters, PVC, leather, Thiokol, nitril, wax, vinyl, cellulose acetates, glass, polystyrol and other materials.



Compact Dial
811-336-10



Compact Digital
811-336-10

MeasurLink ENABLED
Data Management Software by Mitutoyo

Order No	Model	Scale	Display	Graduation	Range	Indenter	List	Promo
811-335-10	HH-335	Shore A	Analog	1.0	10~90	Blunt Taper	\$599.00	\$569.05
811-336-10	HH-336	Shore A	Digital	0.5	10~90	Blunt Taper	\$1,280.00	\$1,216.00
811-337-10	HH-337	Shore D	Analog	1.0	20~90	Sharp Point	\$599.00	\$569.05
811-338-10	HH-338	Shore D	Digital	0.5	20~90	Sharp Point	\$1,280.00	\$1,216.00
64AAA964	Test Block Set (Shore A Scale)						\$188.00	\$178.60
64AAA590	Test Block Set (Shore D Scale)						\$188.00	\$178.60
64AAA962	A Scale Durometer Stand						\$959.00	\$911.05
64AAA796	D Scale Durometer Stand						\$2,500.00	\$2,375.00



HH-411 Hardmatic

Rebound portable hardness tester featuring reproducibility and ease of operation on large parts. It is lightweight and can be carried into the shop or out in the field.



MeasurLink ENABLED
Data Management Software by Mitutoyo

Order No.	Type	List	Promo
810-298	HH-411 Hardmatic	\$4,980	\$3,735
Optional Detectors and Displays			
810-288	DC Type	\$3,310	\$2,980
810-289	D+15 Type	\$3,400	\$3,060

Model	HH-411		
Order No.	810-298		
Hardness Range	L-Value (ASTM A956)		
Detector	Input device D (carbide ball)		
Display	Hardness	Range	Resolution
	HL	1-999 HL	1 HL
	HV	43-950 HV	1 HV
	HB	20-894 HB	1 HB
	HRC	19.3-68.2 HRC	0.1 HRC
	HRB	13.5 - 101.7 HRB	0.1 HRB
	HS	13.2 - 99.3 HS	0.1 HS
	HTN	499 - 1996 Mpa	1 Mpa
Functions	Conversions: HL, HV, HB, HRC, HRB, HS, HTN Judgment: OK/NG Offsetting Memory: 1,800 data		
Output	RS-232C, SPC		
Power supply	Alkaline AA Battery 2pcs.		
Dimensions	Detector: (Dia. X H) 1.10" x 6.89" (28 x 175mm) Display: (W x D x H) 2.76" x 4.33" x 1.38" (70 x 110 x 35mm)		
Mass	Detector: .26lbs (120g) Display: .44lbs (200g)		



810-288
Use for inner walls of cylinders. The grip is short to allow easy positioning within a cylinder.



810-289
Use for concave workpieces such as gear teeth, ball bearing races, etc.



October 24 - 26, 2017
Donald E. Stephens Convention Center
Rosemont, IL
VISIT US AT BOOTH 1308

Rockwell and Rockwell Superficial Hardness Tester

With Real-Time Electronic Test Force Control

- › Closed-loop control of testing forces
- › Primary and final forces (loads) are applied with unparalleled accuracy and repeatability
- › Extended indenter arm reaches inside diameters and hard-to-reach surfaces at eye level, allowing the operator to easily see where the indenter accesses small or hard-to-reach parts
- › Automatic setting of preliminary test force and application of total test force
- › Indenter escape function allows automatic removal of preliminary test force at end of test cycle
- › Touch-screen operation with a back-lit LCD
- › Hardness scale is set automatically via the touch screen
- › Cylindrical and spherical surface compensation
- › Auto conversion to all hardness scales or tensile strength

MeasurLink ENABLED
Data Management Software by Mitutoyo



Model	HR-521	HR-523
Order No.	810-202-03A	810-204-03A
Preliminary Test Force	29.42N (3kgf), 98.07N (10kgf)	
Test Force	Rockwell	588.4N (60kgf), 980.7N (100kgf), 1471N (150kgf)
	Rockwell Superficial	147.1N (15kgf), 294.2N (30kgf), 441.3N (45kgf)
Light Force Brinell	HBW2.5/187.5	HBW1/10, HBW1/30, HBW2.5/6.25, HBW2.5/15.625, HBW2.5/31.25, HBW2.5/62.5, HBW5/25, HBW5/62.5, HBW5/125, HBW10/100
Force Control	Automatic control (unloading/duration/unloading) with closed-loop feed back	
Console/Display Unit	Touch-screen operation with back-lit LCD	
Test Force Selection	Touch screen	
Table up/down drive	Manual (w/Auto-brake mechanism)	Power-Drive (for full-automatic measurement)
Load Duration	0 to 120 sec. (1 sec. step)	
Maximum Specimen Height	8.1" (205mm)	
Maximum Specimen Depth	5.9" (150mm)	
Display Indication Functions	Hardness value, Converted hardness value, Test conditions, go/no-go tolerance judgment, statistical processing result Rockwell/Rockwell superficial hardness testing. Continuous testing. Cylindrical/spherical surface compensation, data offset. Hardness conversion (HV, HK, HRA/B/C/D/F/G/15T/30T/45T/15N/30N/45N, HS, HB, HBW, tensile strength) Go/no-go tolerance judgment, measured data editing, data memory (max 1024 data) SPC calculation (No. of data, max/min/mean values, range, upper/lower limit values, standard deviation, No. of passing/defective) Histogram, \bar{x} -R chart	
Data Output	RS-232C, SPC, Centronics	
Dimensions (W x D x H)	9.84" x 26.38" x 23.82" (250 x 670 x 605mm)	
Mass	60kg	
List	\$15,000.00	\$17,400.00
Promo	\$13,500.00	\$15,660.00

Function: Touch-screen type

- Touch-screen operation with a back-lit LCD graphic display.
- Remote selection of the test force linked to the hardness scale selection.
- Choice of language: English, German, French, Spanish, Italian and Japanese.
- Cylindrical and spherical surface compensation.
- Data offset.
- Conversion to other hardness scales.
- Powerful statistical processing with flexible data point editing and 1024 data memory.
- Measured data editing
- Go/no-go tolerance judgment.
- Statistical processing, histogram and \bar{x} -R chart



Various shapes of specimen can be measured.

(Nose-type indenter axis mechanism has been adopted.) The nose-type indenter mechanism allows measurement of pipe samples as well as the top surface of a flat sample.

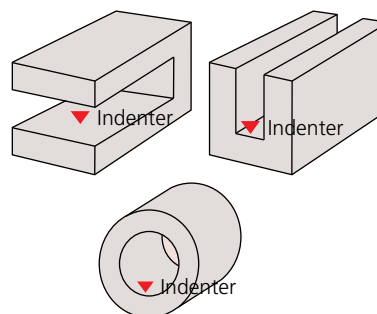

Quill Kit with Absolute Encoder

Easy Installation, Fits Most Vertical Knee Mills

- > Easy-to-read LCD with resolution of .0005"/0.01mm. 0 -6" travel.
- > Push-button controls for inch/mm, Zero-Set and On/Off.
- > Powered by a single SR-44 Battery which lasts about 1 year with normal use.
- > SPC Output for data transmission to data processors or a remote display.

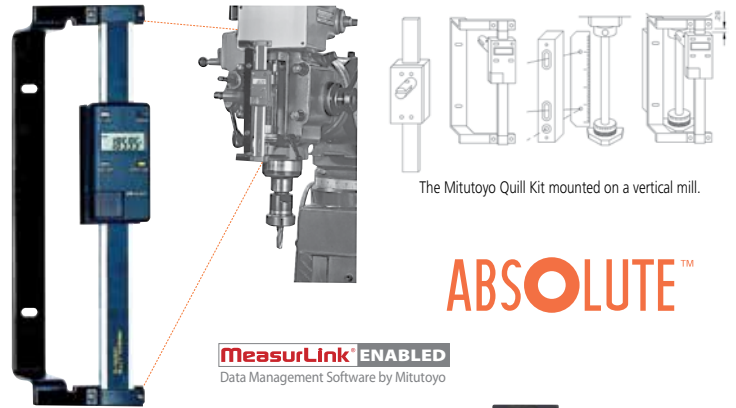

The Mitutoyo Quill Kit mounted on a vertical mill.

ABSOLUTE™

Order No.	Description	List	Promo
053906B	Digimatic Quill Kit complete with brackets & scale for Bridgeport Type machines.	\$310.00	\$279.00

ABSOLUTE Digimatic Scale Units

- > The Origin key allows setting of an absolute zero point to be used as reference in subsequent measurements. Once set, the ABS Digimatic Scale Unit is ready to show its true position whenever turned on, rather than 0.00" as with standard models.
- > The Zero/ABS key allows the display to be zero-set at any slider position along the beam for incremental comparison measurements. This key will also allow return to the absolute coordinate with a display of the true position from the origin point.
- > No rack, no pinion, no glass scale. Digimatic scale unit is safely embedded in the hardened stainless steel blade.
- > Horizontal or vertical face according to the scale mounting direction.
- > Multi-function types with diameter displaying function are also available for lathes. (Contact Mitutoyo.)
- > All units come with two mounting brackets, each located at either end of the scale.
- > With SPC data output.

ABSOLUTE™



MeasurLink ENABLED
Data Management Software by Mitutoyo

Order No	Model	Range	Accuracy	Resolution	Type	List	Promo
572-210-20	SD-4"DX	0-4" / 0-100mm	.001" / 0.03mm	.0005" / 0.01mm	Horizontal single-function	\$235.00	\$223.25
572-211-20	SD-6"DX	0-6" / 0-150mm	.001" / 0.03mm	.0005" / 0.01mm	Horizontal single-function	\$249.00	\$236.55
572-212-20	SD-8"DX	0-8" / 0-200mm	.001" / 0.03mm	.0005" / 0.01mm	Horizontal single-function	\$290.00	\$275.50
572-213-10	SD-12"D	0-12" / 0-300mm	.002" / 0.04mm	.0005" / 0.01mm	Horizontal single-function	\$559.00	\$531.05
572-310-10	SDV-6"D	0-4" / 0-100mm	.001" / 0.03mm	.0005" / 0.01mm	Vertical single function	\$260.00	\$247.00
572-311-10	SDV-6"D	0-6" / 0-150mm	.001" / 0.03mm	.0005" / 0.01mm	Vertical single-function	\$276.00	\$262.20
572-312-10	SDV-8"D	0-8" / 0-200mm	.001" / 0.03mm	.0005" / 0.01mm	Vertical single function	\$320.00	\$304.00
572-313-10	SDV-12"D	0-12" / 0-300mm	.002" / 0.04mm	.0005" / 0.01mm	Vertical single function	\$616.00	\$585.20

Applications

Machine table position

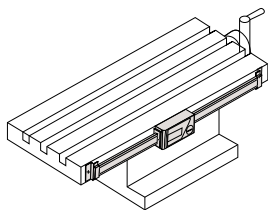

Drilling machine stroke position

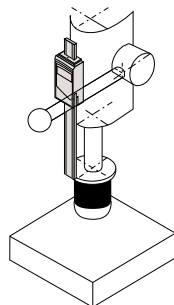

Focus setting on optical instruments

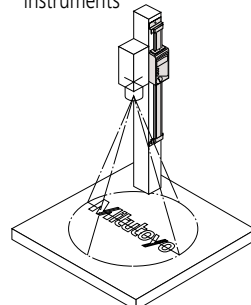

Special Applications

As a measurement jig for outdoor use (SD-G)

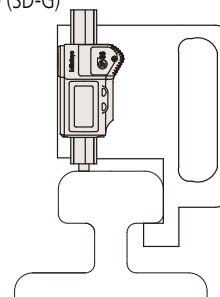

Detector head mechanism

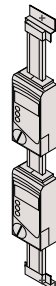

Mitutoyo's Digital Readout Packages

Mounting Hardware Included on all machine retrofit packages

All DRO Packages Include:

- > KA-200 Counter
- > KA-200 Counter tray/arm kit
- > Linear Scales
- > Bracket Kit(s)



SAVE
\$200
PER PACKAGE

MeasurLink ENABLED
Data Management Software by Mitutoyo

Package Part No.	Description	X Travel	Y Travel	Z Travel	X Axis Type	Y Axis Type	Z Axis Type	List	Promo
64PKA058A	12" X 30" DRO Mill Package	30"	12"		AT715	AT715		\$1,490.00	\$1,290.00
64PKA059A	12" X 36" DRO Mill Package	36"	12"		AT715	AT715		\$1,490.00	\$1,290.00
64PKA060A	14" X 30" DRO Mill Package	30"	14"		AT715	AT715		\$1,490.00	\$1,290.00
64PKA062A	16" X 36" DRO Mill Package	36"	16"		AT715	AT715		\$1,490.00	\$1,290.00
64PKA063A	16" X 40" DRO Mill Package	40"	16"		AT715	AT715		\$1,490.00	\$1,290.00
64PKA035A	6" X 28" Lathe Package	6"		28"	AT116		AT715	\$1,450.00	\$1,250.00
64PKA039A	8" X 40" Lathe Package	8"		40"	AT116		AT715	\$1,450.00	\$1,250.00
64PKA042A	10" X 40" Lathe Package	10"		40"	AT116		AT715	\$1,450.00	\$1,250.00
64PKA046A	12" X 40" Lathe Package	12"		40"	AT116		AT715	\$1,450.00	\$1,250.00
64PKA050A	12" X 60" Lathe Package	12"		60"	AT116		AT715	\$1,650.00	\$1,450.00
64PKA052A	14" X 40" Lathe Package	14"		40"	AT116		AT715	\$1,450.00	\$1,250.00
64PKA057A	16" X 60" Lathe Package	16"		60"	AT116		AT715	\$1,650.00	\$1,450.00
64PKA026A	6" X 12" Grinder Package	6"		12"	AT116		AT116	\$1,620.00	\$1,420.00
64PKA028A	8" X 12" Grinder Package	8"		12"	AT116		AT116	\$1,620.00	\$1,420.00
64PKA029A	8" X 14" Grinder Package	8"		14"	AT116		AT116	\$1,620.00	\$1,420.00

Trinocular Stereo Microscope MSM-414TL

- > Continuous 1X - 4X magnification
- > Image always in focus throughout zoom range
- > Crisp, erect images with high resolution and excellent stereoscopic effect
- > Stereo-tube can be rotated a full 360°, for viewing at any angle
- > Bilateral zoom control knob adds convenience and increases operator efficiency
- > Diopter adjustment for both eyepieces

Model	MSM-414TL
Order No.	377-974A
Optical tube	Trinocular
Total magnification	10X - 40X
Eyepiece	10X (377-016)
Objective	1X - 4X
Working distance	80mm
Field of view	20mm - 5mm
Dimensions	H=13.2" x W=6.7" x D=9.3"
Mass	13.2 lbs (6kg)

Order No.	Description	List	Promo
377-974A	MSM-414TL Stereo Microscope	\$1,380.00	\$1,311.00
377-481	C-mount Video Adapter for MSM-414TL	\$53.85	\$51.16
64AAB526	Moticam 1080, 2.0 Mega Pixels, HDMI/USB	\$1,250.00	\$1,187.50



Camera with software for digital viewing



Complimentary Shipping on ALL Profile Projectors*

DOMESTIC U.S. ORDERS ONLY



*Complimentary ground shipping for the 48 contiguous United States. Offer applies to orders placed September 12 through December 22, 2017. Mitutoyo America Corporation reserves the right to change or discontinue this offer at any time. This offer is void wherever prohibited or restricted by law. No cash value. For Alaska and Hawaii special rates apply. Contact us for details.

Complimentary shipping cannot be applied toward previously placed orders. Orders may only be shipped to a single address. If customer returns product, they are responsible for the shipping cost. Refer to our terms and conditions for further details.

PH-A14 Horizontal Profile Projector

- > Mitutoyo's lens technology and workmanship combine to provide a bright, crisp image for error-free inspection.
- > 8" x 4" floating-type workstage incorporates linear scales for fast, accurate measurement.
- > The workstage provides high accuracy and can handle a workload of up to 100 lbs.
- > 10x objective lens and fiber illuminator are standard accessories.



MeasurLink ENABLED
Data Management Software by Mitutoyo



KA 200 Counter



QM Data
2-D Data
Processing Unit

MAC No.	Description	List
64PKA086A	PH-A14 w/KA-200 Counter & Tray	\$6,380.00
64PKA087	PH-A14 w/QM Data (Arm Mount)	\$8,290.00

Prices effective September 12 through December 22, 2017

PH-3515F Horizontal Profile Projector

- > Erect image on high brightness screen.
- > 14" (353mm) dia. protractor screen with crosshairs and staggered lines for easy alignment.
- > Suitable for thread pitch measurements—free from blurred or distorted images when the workpiece is angled.
- > Digital angle measurement of 1' or 0.01° with built in angle counter.
- > Floating-type workstage incorporates linear scales for fast, accurate measurement.
- > Halogen contour illumination.
- > Fiber-optic illumination cables and halogen included.



MeasurLink ENABLED
Data Management Software by Mitutoyo



KA 200 Counter



QM Data
2-D Data
Processing Unit

MAC No.	Description	List
64PKA088A	PH-3515F w/QM Data (Arm Mount)	\$13,500.00
64PKA089B	PH-3515F W/ KA-200 Counter & Tray	\$11,600.00



VIDEO DEMO

PV-5110 Profile Projector

- > Large 500mm screen
- > Floor model uses a downward illumination system.
- > Digital readout protractor screen (including zero-setting, ABS/INC coordinate switching functions) for easy and error-free angle measurement.
- > Angled screen allows projected images to be easily traced or compared with a template.
- > The oblique surface illumination system provides clear and bright images, allowing easy inspection of non-reflective workpieces such as plastic parts or printed materials.

Standard Accessories

- > 200 x 100mm (8 x 4") XY travel
- > 10x projection lens set
- > Surface illumination unit
- > Counter stand for KA counter
- > Power cord, halogen bulb, fuse, grounding wire, allen wrench, vinyl cover



PV-5110



MeasurLink ENABLED
Data Management Software by Mitutoyo

Order No.	Description	List
304-919A	Profile Projector PV-5110	\$24,200.00
264-156A	QM-Data200 (Arm-Mount Model)	\$2,720.00
332-151	Optoeye-200	\$1,650.00
12AAE672	Attachment (B) for Optoeye-200	\$58.65
174-183A	KA 200 Counter	\$587.00



KA 200 Counter

PJ-A3000 Vertical Profile Projector

- > A series of midsize profile projectors featuring bright, 12.40" (315mm) diameter screens and easy-to-operate XY measurement tables.
- > A floating table makes measuring quick and easy.
- > Built-in, easy-to-read digital counters are located near the projection screen, thereby minimizing strain associated with excessive movement.
- > For edge-sensing capabilities, order the Optoeye-200, part number 332-151.



PJ-A3010F-200

MeasurLink ENABLED
Data Management Software by Mitutoyo

Order No.	Description	XY Travel	List
302-701A	PJ-A3010F-200	8" x 4"	\$13,600.00
302-702A	PJ-A3005F-150	6" x 2"	\$12,000.00
302-703A	PJ-A3010F-100	4" x 4"	\$10,800.00
302-704A	PJ-A3005D-50	2" x 2"	\$8,890.00

Optional Accessories

Order No.	Description	List
264-156A	QM-Data 200 (Arm-Mount Model)	\$2,720.00
332-151	Optoeye 200	\$1,650.00
64PMI167	Stand for PJ-A3000	\$688.00
12AAA807	RS-232C Cable	\$54.30
12AAE671	Attachment board (A) for Optoeye-200	\$40.80



Optoeye-200
Edge detection system



QM Data
2-D Data
Processing Unit



Mitutoyo America Corporation

965 Corporate Boulevard
Aurora, Illinois 60502
1-888-648-8869

FALL PROMO 2017

PRECISION TOOLS & INSTRUMENTS

Mitutoyo products are sold only through authorized distributors. To find an authorized Mitutoyo distributor near you, visit: www.mitutoyo.com/distributor-locator/



October 24 – 26, 2017
Donald E. Stephens Convention Center
Rosemont, IL

VISIT US AT BOOTH 1308

2017 Tradeshow Schedule:

- Oct. 3-5 Wisconsin Manufacturing & Technology, Milwaukee, WI. www.epishows.com/wmts
- Oct. 24-26 Heat Treat, Columbus, OH. www.asminternational.org/web/heat-treat-2017
- Oct. 24-26 The Quality Show, Rosemont, IL. www.qualityshow.com
- Nov. 11-15 Neuroscience 2017, Washington, D.C. www.sfn.org/annual-meeting/neuroscience-2017

Note: All information regarding our products, and in particular the illustrations, drawings, dimensional and performance data contained in this printed matter as well as other technical data are to be regarded as approximate average values. We therefore reserve the right to make changes to the corresponding designs. The stated standards, similar technical regulations, descriptions and illustrations of the products were valid at the time of printing. In addition, the latest applicable version of our General Trading Conditions will apply. Only quotations submitted by ourselves may be regarded as definitive. Specifications are subject to change without notice.

Mitutoyo products are subject to US Export Administration Regulations (EAR). Re-export or relocation of our products may require prior approval by an appropriate governing authority.

Trademarks and Registrations

Designations used by companies to distinguish their products are often claimed as trademarks. In all instances where Mitutoyo America Corporation is aware of a claim, the product names appear in initial capital or all capital letters. The appropriate companies should be contacted for more complete trademark and registration information.

We reserve the right to change specifications and prices without notice. Not valid with any other offer or promotion, previous purchases. Please refer to terms and conditions for additional information. Domestic U.S. orders only.

© 2017 Mitutoyo America Corporation

40M 0817-INT-02 • Printed in USA • Sept. 2017



FALL PROMO 2017

PRECISION TOOLS & INSTRUMENTS

Effective September 12 through December 22, 2017

FALL PROMO 2017

MeasurLink[®] ENABLED
Data Management Software by Mitutoyo

