



SPRING PROMO 2016 PRECISION TOOLS & INSTRUMENTS

Effective May 1 through July 29, 2016

SPRING PROMO 2016

COOLANT PROOF™

COOLANT PROOF is the universal term of Mitutoyo Digimatic Small Tool Instruments that are free from measurement error and physical deterioration due to routine exposure to water, cutting oil or coolant. This high performance is achieved by using encoders that are inherently immune to contamination, where exposure is inevitable, combined with comprehensive sealing techniques and extremely oil-resistant materials to guarantee a long working life under normal operating conditions.



Mitutoyo Quality



Dear Valued Customers,

We wanted to take this opportunity to personally thank the companies and individuals who partner with us, for their continued support and commitment.

The Spring Promotion is our first large-scale Precision Tools & Instruments Promotion of 2016 and will be effective from May 1, through July 29, 2016.

Please check our website at www.mitutoyo.com to watch for other new products, promotions and events during 2016.

Sincerely,

Shigeyuki Sasaki
President, Mitutoyo America Corporation



Prices effective May 1 through July 29, 2016



COOLANT PROOF™ IP67

COOLANT PROOF is the universal term of Mitutoyo Digimatic Small Tool Instruments that are free from measurement error and physical deterioration due to routine exposure to water, cutting oil or coolant. This high performance is achieved by using encoders that are inherently immune to contamination, where exposure is inevitable, combined with comprehensive sealing techniques and extremely oil-resistant materials to guarantee a long working life under normal operating conditions.

ABSOLUTE Coolant-Proof Calipers

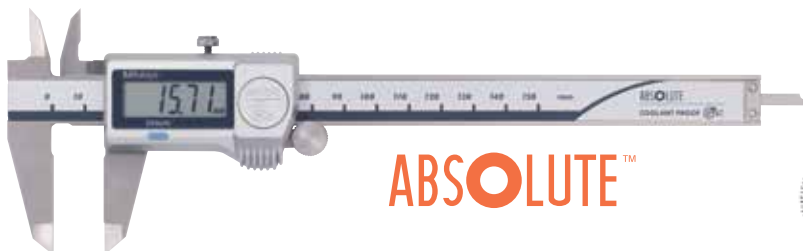

Order No.	Range	List	Promo
Non-Output Style			
500-752-10	0-6"/0-150mm	\$209.00	\$198.55
500-753-10	0-8"/0-200mm	\$280.00	\$266.00
500-754-10*	0-12"/0-300mm	\$484.00	\$459.80
SPC Output Style			
500-762-10	0-6"/0-150mm	\$248.00	\$235.60
500-763-20	0-8"/0-200mm	\$312.00	\$296.40
500-764-10*	0-12"/0-300mm	\$537.00	\$510.15

* ±.0015" accuracy

Features

- Its sealed housing is IP-67 rated, meaning it's immune to the coolants, dirt, grit and chips found in many manufacturing environments.
- .0005"/0.01mm resolution with ±.001" accuracy.
- Certificate of inspection provided

Super Solar Calipers



Features

- Absolute Encoder Technology
- No battery needed
- Works in low lighting conditions above 60 luxes
- Super capacitor power back-up
- 0.0005"/0.01mm resolution
- Certificate of inspection provided
- RoHS compliant



COOLANT PROOF™ IP67

Order No.	Range	Description	List	Promo
500-784	0-6"/0-150mm	no output	\$239.00	\$227.05
500-785	0-8"/0-200mm	no output	\$306.00	\$290.70
500-786	0-6"/0-150mm	w/SPC output	\$267.00	\$253.65
500-787	0-8"/0-200mm	w/SPC output	\$330.00	\$313.50

ABSOLUTE™

Absolute System Patented by MITUTOYO

SPC Cables

Order No.	Description	List	Promo
05CZA624	40" SPC Cable	\$93.90	\$89.20
05CZA625	80" SPC Cable	\$95.35	\$90.60



ABSOLUTE Digimatic Calipers

AOS* Absolute Digimatic Calipers

A new series of digimatic calipers derived from 30 years of accumulated Mitutoyo technologies. The patented Advanced Onsite Sensor (AOS) offers improved measurements dependability by increasing resistance to harsh workshop conditions.

Features

- Electromagnetic inductive sensor improves environmental resistance against dirt, water and oil.
- A battery life of approximately 3.5 years has been achieved under normal use through the adoption of Mitutoyo's ABSOLUTE scale.
- The slider configuration features an ergonomic, thumb-friendly shape.
- Step-measurement capable.
- The data output function allows integration into statistical process control and measurement systems.
- Display character height: 9mm
- * AOS applies to 4", 6" and 8" models



ABSOLUTE™



AOS: Advanced Onsite Sensor



www.mitutoyo.com/aoscd
VIDEO DEMO

Order No.	Description	List	Promo
959149	40" SPC Cable	\$49.25	\$46.80
959150	80" SPC Cable	\$55.20	\$52.45

Order No.	Range	Remarks	List	Promo
No SPC Output Style				
500-195-30	0-4"/0-100mm	.075" Round depth bar	\$144.00	\$136.80
500-196-30	0-6"/0-150mm		\$156.00	\$148.20
500-197-30	0-8"/0-200mm		\$224.00	\$212.80
500-193	0-12"/0-300mm		\$450.00	\$427.50
With SPC Output Style				
500-170-30	0-4"/0-100mm	.075" Round depth bar	\$172.00	\$163.40
500-171-30	0-6"/0-150mm		\$183.00	\$173.85
500-172-30	0-8"/0-200mm		\$241.00	\$228.95
500-173	0-12"/0-300mm		\$525.00	\$498.75
500-505-10	0-18"/0-450mm	Without Thumb Roller	\$819.00	\$778.05
500-506-10	0-24"/0-600mm	Without Thumb Roller	\$900.00	\$855.00
500-507-10	0-40"/0-1000mm	Without Thumb Roller	\$1,740.00	\$1,653.00

Dial Calipers

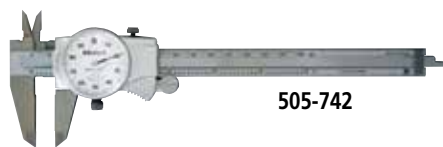

505-742



505-746

Features

- Newly designed dial movement for ultra smooth sliding and high shock protection.
- Stainless steel.
- .001" graduations.
- Lock screw for dial bezel and for holding the sliding jaw position.
- Can measure OD, ID, depth and steps.
- Models available with carbide-tipped OD and ID jaws.

Order No.	Range	Remarks	List	Promo
505-742	6" .100"/rev.		\$121.00	\$108.90
505-738	6" .100"/rev.	Carbide-Tipped Jaws	\$207.00	\$186.30
505-740	6" .200"/rev.		\$111.00	\$99.90
505-743	8" .100"/rev		\$177.00	\$159.30
505-746	12" .100/rev		\$281.00	\$252.90
505-749	12" .200/rev		\$261.00	\$234.90

Vernier Calipers



530-104

Features

- Can measure OD, ID, depth and steps.
- The small vernier face angle (14°) provides easy-reading.
- Dual reading scales on vernier.
- Lock screw for holding the sliding jaw position.
- Carbide-tipped jaw type calipers are also available.

Order No.	Range	Vernier Graduation		Remarks	List	Promo
		Lower Scale	Upper Scale			
530-104	0 - 150mm / 0 - 6"	0.05mm	1/128"		\$75.90	\$72.10
530-312	0 - 150mm / 0 - 6"	0.02mm	.001"	High-accuracy model	\$105.00	\$99.75
530-114	0 - 200mm / 0 - 8"	0.05mm	1/128"		\$124.00	\$117.80
530-118	0 - 200mm / 0 - 8"	0.02mm	.001"	High-accuracy model	\$124.00	\$117.80
530-115	0 - 300mm / 0 - 12"	0.05mm	1/128"		\$237.00	\$225.15
530-119	0 - 300mm / 0 - 12"	0.02mm	.001"	High-accuracy model	\$232.00	\$220.40

MDC Micrometers

COOLANT PROOF™

Features

- New electromagnetic ABSOLUTE sensor - Improved resistance to environmental conditions such as dirt, oil and water that can cause false readings.
- New ratchet thimble models improve one-hand operability.
- New Anti-slip finish for improved grip while taking measurements.
- Long battery life – 2.4 years under normal operation.
- Fully compatible with existing Mitutoyo Digimatic peripherals (SPC Cables, U-Wave wireless transmitters, DP1-VR, etc.) – SPC output-enabled IP65 models.
- Function-lock system prevents inadvertent setting changes.
- Certificate of inspection provided.

IP65



293-330-30



www.mitutoyo.com/MDC
VIDEO DEMO

Order No.	Range	Resolution	Remarks	List	Promo
IP65 - With SPC Output					
293-330-30	0-1"/0-25.4mm	.00005"/0.001mm	Ratchet Stop	\$240.00	\$228.00
293-331-30	1-2"/25.4-50.8mm	.00005"/0.001mm	Ratchet Stop w/Standard	\$283.00	\$268.85
IP65 - Non-SPC Output					
293-340-30	0-1"/0-25.4mm	.00005"/0.001mm	Ratchet Stop	\$187.00	\$177.65
293-344-30	0-1"/0-25.4mm	.00005"/0.001mm	Ratchet Thimble	\$187.00	\$177.65
293-348-30	0-1"/0-25.4mm	.00005"/0.001mm	Friction Thimble	\$187.00	\$177.65
293-349-30	0-1"/0-25.4mm	.0001"/0.001mm	Ratchet Thimble	\$187.00	\$177.65
293-341-30	1-2"/25.4-50.8mm	.00005"/0.001mm	Ratchet Stop w/Standard	\$243.00	\$230.85
293-345-30	1-2"/25.4-50.8mm	.00005"/0.001mm	Ratchet Thimble w/Standard	\$243.00	\$230.85

Order No.	Description	List	Promo
05CZA662	40" SPC Cable	\$83.80	\$79.60
05CZA663	80" SPC Cable	\$92.45	\$87.85



Improved operability with one hand



Outside Micrometers — Inch Models

Features

- Carbide measuring faces.
- Hammertone, baked enamel-finished frame.
- With a standard bar except for 0-1" model.
- Certificate of inspection provided (0-1" ,1-2" models only).

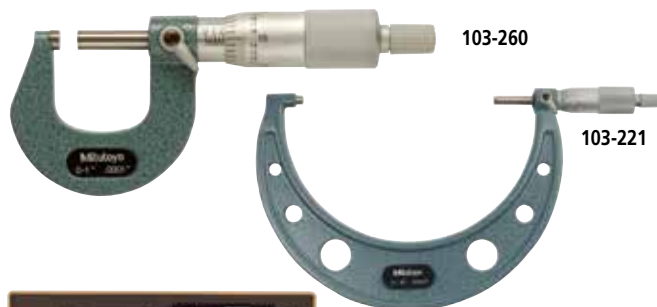

103-922

Order No.	Range	Graduations	Remarks	List	Promo
103-260	0-1"	.0001"	Ratchet Stop	\$118.00	\$106.20
103-262	1-2"	.0001"	Ratchet Stop	\$138.00	\$124.20
103-132	1-2"	.0001"	Ratchet Stop	\$122.00	\$109.80
103-217	2-3"	.0001"	Ratchet Stop	\$154.00	\$138.60
103-218	3-4"	.0001"	Ratchet Stop	\$177.00	\$159.30
103-219	4-5"	.0001"	Ratchet Stop	\$192.00	\$172.80
103-220	5-6"	.0001"	Ratchet Stop	\$213.00	\$191.70
103-221	6-7"	.0001"	Ratchet Stop	\$241.00	\$216.90
103-222	7-8"	.0001"	Ratchet Stop	\$254.00	\$228.60
103-223	8-9"	.0001"	Ratchet Stop	\$282.00	\$253.80
103-224	9-10"	.0001"	Ratchet Stop	\$292.00	\$262.80
103-225	10-11"	.0001"	Ratchet Stop	\$306.00	\$275.40
103-226	11-12"	.0001"	Ratchet Stop	\$319.00	\$287.10
Micrometer Sets					
103-922	0-3"	3 pcs/set includes: 103-135, 103-136, 103-217, 2pcs. Micrometer Standards		\$431.00	\$387.90

Prices effective May 1 through July 29, 2016

QuantuMike Micrometer 4X Faster Spindle Travel



COOLANT PROOF™

Features

- Faster measurement with 2mm travel per revolution instead of the standard 0.5mm.
- A patented ratchet thimble mechanism helps ensure repeatability.
- A Function lock helps prevent error.
- IP-65 protection level.
- Certificate of inspection provided.



www.mitutoyo.com/qm4x
VIDEO DEMO

Significant reduction in positioning time

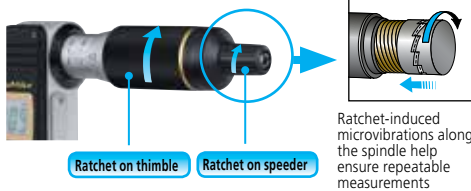
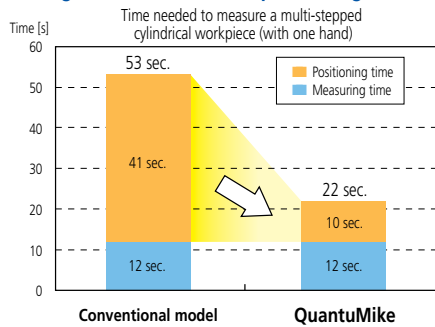

Order No.	Range	Resolution	List	Promo
293-180*	0-1"/0-25mm	.00005"/0.001mm	\$262.00	\$248.90
293-181*	1-2"/25-50mm	.00005"/0.001mm	\$300.00	\$285.00
293-185	0-1"/0-25mm	.00005"/0.001mm	\$226.00	\$214.70
293-186	1-2"/25-50mm	.00005"/0.001mm	\$258.00	\$245.10
293-182*	2-3"/50.8 - 76.2mm	.00005"/0.001mm	\$358.00	\$340.10
293-187	2-3"/50.8 - 76.2mm	.00005"/0.001mm	\$310.00	\$294.50
293-183*	3-4"/76.2 - 101.6mm	.00005"/0.001mm	\$385.00	\$365.75
293-188	3-4"/76.2 - 101.6mm	.00005"/0.001mm	\$372.00	\$353.40

*with SPC Output

Order No.	Description	List	Promo
05CZA662	40" SPC Cable	\$83.80	\$79.60
05CZA663	80" SPC Cable	\$92.45	\$87.85



MDH Micrometer High-Accuracy Sub-Micron Digimatic Micrometer



www.mitutoyo.com/MDH

Features

- Enabling .00005"/0.1µm resolution measurement, this micrometer is ideal for customers who need to make highly accurate measurements with a handheld tool.
- The ABS (absolute) rotary sensor also eliminates the need to perform origin setting each time the power is turned on, letting you start measuring right away. With no possibility of overspeed errors, the High-Accuracy Digimatic Micrometer also delivers a higher level of reliability.
- Certificate of inspection provided.

Order No.	Range	Resolution	Accuracy	List	Promo
293-100	0 - 25mm	0.0001mm/ 0.0005mm (switchable)	±0.5µm	\$1,630.00	\$1,548.50
293-130	0 - 1" 0 - 25.4mm	.00005"/.00002" 0.0001mm/0.0005mm (switchable)	±.00002"	\$1,630.00	\$1,548.50

Order No.	Description	List	Promo
05CZA662	40" SPC Cable	\$83.80	\$79.60
05CZA663	80" SPC Cable	\$92.45	\$87.85



Function lock

Micrometer Stand

The micrometer stand is designed to provide the convenience of a benchtop tool with hand micrometers or other gages.



For micrometers ranging in size .5" - 4".
Micrometer sold separately.

Order No.	Description	List	Promo
156-101-10	Micrometer Stand	\$110.00	\$99.00

IDC Digimatic Indicators

Features

- Absolute Encoder ensures all settings and readings maintained for the life of the battery (even when the power is turned off).
- Preset, Zero-Set, inch/mm, +/- direction and go/no-go functions.
- Face rotates 330° for use at various angles.
- Stem diameter: .375".
- Immune to overspeed error.
- SPC output provided.
- Average battery life 7,000 hours using SR-44 battery (541980).

Order No.	Range	Remarks	List	Promo
.0005"/0.01mm Resolution				
543-402	.500"/12.7mm	Lug Back	\$310.00	\$294.50
543-402B	.500"/12.7mm	Flat Back	\$310.00	\$294.50
543-476B	1"/25mm	Flat Back	\$454.00	\$431.30
543-496B	2"/50mm	Flat Back	\$597.00	\$567.15
.00005"/.0001"/.0005"/0.001mm/0.01mm Resolution*				
543-392	.500"/12.7mm	Lug Back	\$424.00	\$402.80
543-392B	.500"/12.7mm	Flat Back	\$424.00	\$402.80
543-472B	1"/25mm	Flat Back	\$568.00	\$539.60
543-492B	2"/50mm	Flat Back	\$713.00	\$677.35



Now with multiplier function $f(x)=Ax$ (other models available with $Ax+B+Cx-1$ function, contact Mitutoyo)

*Models available with selectable resolutions: .00005"/.0001"/.0005"/0.001mm/0.01mm



Order No.	Description	List	Promo
905338	40" SPC Cable	\$40.05	\$38.05
905409	80" SPC Cable	\$47.75	\$45.35

• Three large buttons

The popular three-large button design, which is used in products such as the ABS coolant-proof Digimatic indicators ID-N/B, makes buttons easier to press and operations easier to perform.



• Power switch

- Data output (when connected to an external device)
- Data hold (when no external device is connected)

Switches between the ABS (preset) and INC (zeroset) measurement modes

• Parameter setting mode

Count direction switching, tolerance judgment setting, resolution switching, scale factor setting, and function lock setting

- inch/mm conversion (inch/mm models)

• 330° rotary display

The display can be rotated 330°, allowing use at a position where you can easily read the measurement value.



Digimatic Thickness Gages

The Thickness Gages offer a quick and efficient means of inspection with their convenient grip handle, thumb trigger and spring-loaded spindle. The various models cover a wide range of applications.



Order No.	Range	Resolution	List	Promo
547-400S	0-.47"/0-12mm	.00005"/0.001mm	\$831.00	\$789.45
547-520S	0-.47"/0-12mm	.0005"/0.01mm	\$304.00	\$288.80

Order No.	Description	List	Promo
905338	40" SPC Cable	\$40.05	\$38.05
905409	80" SPC Cable	\$47.75	\$45.35



www.mitutoyo.com/thicknessgag
VIDEO DEMO



Prices effective May 1 through July 29, 2016

Series One Dial Indicators

Mitutoyo's Dial Indicators now offer users more stability and longer life, thanks to advances to the inner workings of the rack and pinion gear system. Shock resistance is increased with a more robust gear train, while contamination resistance has been dramatically increased over other indicators of this type with a tighter seal around the bezel and frame, and the elimination of a lifting lever screw.



1507S

Order No.	Graduation	Range	Accuracy	Dial Face	List	Promo
1410S	.001"	.25"	±.001"	0-100	\$108.00	\$97.20
1410S-10**	.001"	.25"	±.001"	0-100	\$112.00	\$100.80
1410SB*	.001"	.25"	±.001"	0-100	\$108.00	\$97.20
1506S	.0005"	.125"	±.0005"	0-50	\$99.80	\$89.80
1507S	.0005"	.125"	±.0005"	0-25-0	\$99.80	\$89.80

* with flat back ** jeweled



2776S

Series Two Dial Indicators

Order No.	Graduation	Range/Rev	Type	Dial Reading	Accuracy First 2.5 Rev/Overall	Force	List	Promo
2776S	.0005"	1" / .05"	w/lug	0-50	.0005 / .002	2.5N or less	\$142.00	\$127.80

"Quick-Set" Test Indicators

The most direct gear train design ever applied to test indicators means higher levels of sensitivity, reliability, repeatability and accuracy throughout tool life.

Features

- Anti-magnetic
- Jeweled bearings
- No-clutch structure
- Water- and dust-resistant
- Glare-free crystal with scratch-resistant coating
- Metric dial faces in yellow
- Measuring force 0.3N or less

Order No.	Graduation	Range	Dial Face	Remarks	List	Promo
513-402	.0005"	.030"	0-15-0	Anti Magnet, Jeweled	\$130.00	\$123.50
513-402T	.0005"	.030"	0-15-0	Anti Magnet, Jeweled Set	\$154.00	\$146.30
513-412	.0005"	.030"	0-15-0	Long Point	\$186.00	\$176.70
513-412T	.0005"	.030"	0-15-0	Long Point Set	\$215.00	\$204.25
513-403	.0001"	.008"	0-4-0	Anti Magnet, Jeweled	\$169.00	\$160.55
513-403T	.0001"	.008"	0-4-0	Anti Magnet, Jeweled Set	\$198.00	\$188.10



513-412

Dial Gage Stands

Order No.	Max. Ht. Capacity	Anvil Type	List	Promo
7007-10	3.54"	Square Serrated Anvil	\$554.00	\$526.30
7001-10	4.0"	Round Serrated Anvil	\$554.00	\$526.30
7002-10	4.0"	Round Flat Anvil	\$554.00	\$526.30

The compact and versatile Dial Gage Stands are commonly used general-purpose stands for comparison measurements, 4" maximum height capacity. They feature a wide fine adjusting range for zero-setting gage heads.



7007-10



7001-10

This Dial Gage Stand provides an ideal work base for all AGD type indicators as well as other gages.

Digimatic Height Gages (Multi-Function Type)

Now with two resolutions (.0002"/.0005"), two value preset memory and increased character height for easier viewing.

Features

- Highly versatile, multi-function type.
- Carbide-tipped long scriber is provided.
- Rigid construction ensures repeatable measurement.
- Switchable resolution.
- Coarse/fine feed switching.
- With SPC data output.
- Two preset reference height.

Functions include:

- Zero/ABS setting (ABS and INC modes)
- Two-value preset memory
- Data/hold
- ± Counting
- Inch/mm conversion

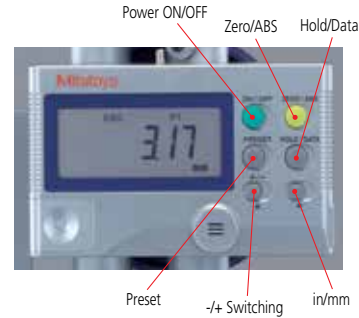

192-670-10

Order No.	Range	Resolution	Accuracy	List	Promo
192-670-10	0-12"/0-300mm	.0005" (0.01mm)	±001"	\$1,770.00	\$1,593.00
192-671-10	0-18"/0-450mm	.0002" (0.005mm) [Switchable]	±0015"	\$2,280.00	\$2,052.00
192-672-10	0-24"/0-600mm		±0015"	\$2,920.00	\$2,628.00

Order No.	Description	List	Promo
905338	40" SPC Cable	\$40.05	\$38.05
905409	80" SPC Cable	\$47.75	\$45.35

Dial Height Gages

Double-column structure ensures high measuring accuracy. Coarse/Fine Feed switching. Carbide-tipped scriber.



192-150

Features

- Easy and error-free reading with both up and down digital counters as well as a dial.
- Provided with a feed wheel for easy coarse feeding.
- Carbide-tipped scriber is provided.
- The counters and dial can be re-zeroed at any scriber position.



Order No.	Range	Graduation	List	Promo
192-150	0-12"	.001"	\$1,010.00	\$909.00
192-151	0-18"	.001"	\$1,400.00	\$1,260.00
192-152	0 - 24"	.001"	\$1,820.00	\$1,638.00

Rectangular Steel Gage Block Sets



516-902-26

Order No.	Blocks per Set	Grade	Size	Step	Qty	List	Promo
516-902-26	81	0	.1001 - .1009"	.0001"	9	\$1,970.00	\$1,773.00
			.101 - .149"	.001"	49		
			.05 - .95"	.05"	19		
			1 - 4"	1"	4		
516-903-26	81	AS-1	.1001-.1009"	.0001"	9	\$1,710.00	\$1,539.00
			.101-.149"	.001"	49		
			.05-.95"	.05"	19		
			1-4"	1"	4		
516-904-26	81	AS-2	.1001-.1009"	.0001"	9	\$1,550.00	\$1,395.00
			.101-.149"	.001"	49		
			.05-.95"	.05"	19		
			1-4"	1"	4		
516-914-26	35	0	.10005"		1	\$1,040.00	\$936.00
			.1001-.1009"	.0001"	9		
			.101-.149"	.001"	9		
			.11-.19"	.01"	9		
			.1-.3"	.1"	3		
			.5, 1, 2, 4"		4		
516-947-26	87	AS-1	1.001-1.009mm	0.001mm	9	\$2,460.00	\$2,214.00
			1.01-1.49mm	0.01mm	49		
			0.5-9.5mm	0.5mm	19		
			10-100mm	10	10		

Order No.	Blocks per Set	Grade	Blocks Incl. In Set	Remarks	List	Promo
516-930-26	9	0	.0625", .100", .125", .200", .250", .300", .500"	Optical parallel (t = .5")	\$360.00	\$324.00
516-931-26	9	AS-1	.500", 1", 2"		\$314.00	\$282.60
516-935-26	9	AS-1	.0625", .100", .125", .200", .250", .300", .500", 1", 2"		\$242.00	\$217.80

Prices effective May 1 through July 29, 2016

Digimatic Holtest

Features

- TiN-coated measuring contact points provide excellent durability and impact resistance and allow the instrument to measure close to the bottom of blind holes (up to 100mm / 4" models).
- Large LCD readout.
- Functions available: Presetting, Zero/ABS, Auto power On/Off, Data hold, Data output, Error alarm, Battery replacement alarm.
- With Ratchet Stop for constant force.
- Can measure deep holes by attaching an extension rod (optional).
- Setting rings are included in sets, but optional for individual gages.
- Supplied in fitted plastic case up to 100mm / 4". Over 100mm / 4" supplied in wooden case.
- Resolution: .00005"/0.001mm (over 4" models: .0001"/0.001mm)



SAVE 20%



www.mitutoyo.com/dholtest
VIDEO DEMO



Order No	Range	Accuracy	List	Promo
Individual Gages				
468-261	.275 - .35" / 6.925 - 8.89mm	±.0001"	\$1,110.00	\$888.00
468-262	.35 - .425" / 8.89 - 10.795mm	±.0001"	\$1,110.00	\$888.00
468-263	.425 - .5" / 10.795 - 12.7mm	±.0001"	\$1,120.00	\$896.00
468-264	.5 - .65" / 12.7 - 16.51mm	±.0001"	\$1,220.00	\$976.00
468-265	.65 - .8" / 16.51 - 20.32mm	±.0001"	\$1,220.00	\$976.00
468-266	.8 - 1" / 20.32 - 25.4mm	±.00015"	\$1,250.00	\$1,000.00
468-267	1 - 1.2" / 25.4 - 30.48mm	±.00015"	\$1,250.00	\$1,000.00
468-268	1.2 - 1.6" / 30.48 - 40.64mm	±.00015"	\$1,280.00	\$1,024.00
468-269	1.6 - 2" / 40.64 - 50.8mm	±.00015"	\$1,290.00	\$1,032.00
468-270	2 - 2.5" / 50.8 - 63.5mm	±.00015"	\$1,400.00	\$1,120.00
468-271	2.5 - 3" / 63.5 - 76.2mm	±.00015"	\$1,400.00	\$1,120.00
468-272	3 - 3.5" / 76.2 - 88.9mm	±.00015"	\$1,420.00	\$1,136.00
468-273	3.5 - 4" / 88.9 - 101.6mm	±.00015"	\$1,440.00	\$1,152.00
468-274	4 - 5" / 101.6 - 127mm	±.00025"	\$1,880.00	\$1,504.00
468-275	5 - 6" / 127 - 152.4mm	±.00025"	\$1,930.00	\$1,544.00
468-276	6 - 7" / 152.4 - 177.8mm	±.00025"	\$2,050.00	\$1,640.00
468-277	7 - 8" / 177.8 - 203.2mm	±.00025"	\$2,140.00	\$1,712.00
468-278	8 - 9" / 203.2 - 228.6mm	±.00025"	\$2,280.00	\$1,824.00
468-279	9 - 10" / 228.6 - 254mm	±.00025"	\$2,330.00	\$1,864.00
468-280	10 - 11" / 254 - 279.4mm	±.00025"	\$2,410.00	\$1,928.00
468-281	11 - 12" / 279.4 - 304.8mm	±.00025"	\$2,520.00	\$2,016.00
Interchangeable Head Sets				
468-976	.275 - .5" / 6.925 - 12.7mm	±.0001"	\$2,030.00	\$1,624.00
468-977	.5 - .8" / 12.7 - 20.32mm	±.0001"	\$1,650.00	\$1,320.00
468-978	.8 - 2" / 20.32 - 50.8mm	±.00015"	\$4,120.00	\$3,296.00
468-979	2 - 4" / 50.8 - 101.6mm	±.00015"	\$4,720.00	\$3,776.00
468-980	4 - 8" / 101.6 - 203.2mm	±.00025"	\$5,540.00	\$4,432.00
Complete Unit Sets				
468-986	.275 - .5" / 6.925 - 12.7mm	±.0001"	\$3,960.00	\$3,168.00
468-987	.5 - 1" / 12.7 - 25.4mm	±.0001"	\$4,200.00	\$3,360.00
468-988	1 - 2" / 25.4 - 50.8mm	±.00015"	\$4,760.00	\$3,808.00
468-989	2 - 3" / 50.8 - 76.2mm	±.00015"	\$5,350.00	\$4,280.00
468-990	3 - 4" / 76.2 - 101.6mm	±.00015"	\$6,290.00	\$5,032.00

Optional Accessories

04AZB157: Mounting plate for stand

156-101-10: Stand

952322: Extension rod 100mm / 3.94"
For range 6-12mm / .275 - .5" models

952621: Extension rod 150mm / 5.9"
For range 12-20mm / .5" - .8" models

952622: Extension rod 150mm / 5.9"
For range 20-50mm / .8" - 2" models

952623: Extension rod 150mm / 5.9"
For range 50-300mm / 2" - 12" models



Order No.	Description	List	Promo
05CZA662	40" SPC Cable	\$83.80	\$79.60
05CZA663	80" SPC Cable	\$92.45	\$87.85



Quill Kit with Absolute Encoder

Easy Installation, Fits Most Vertical Knee Mills

Features

- Easy-to-read LCD with resolution of .0005"/0.01mm. 0 -6" travel.
- Push button controls for inch/mm, Zero-Set and On/Off.
- Powered by a single SR-44 Battery which lasts about 1 year with normal use.
- SPC Output for data transmission to Data Processors or a Remote Display.

Order No.	Description	List	Promo
053906B	Digimatic Quill Kit complete with brackets & scale for Bridgeport Type machines.	\$310.00	\$279.00

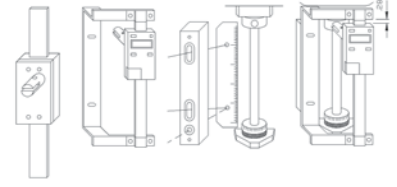
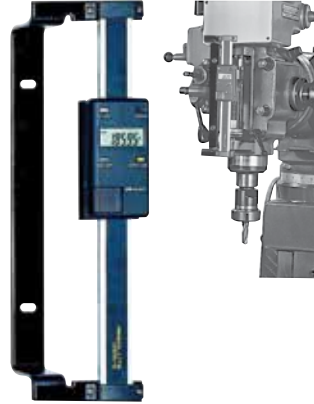

The Mitutoyo Quill Kit mounted on a vertical mill.

ABSOLUTE™

ABSOLUTE Digimatic Scale Units

Features

- The ORIGIN key allows setting of an absolute zero point to be used as reference in subsequent measurements. Once set, the ABS Digimatic Scale Unit is ready to show its true position whenever turned on, rather than 0.00" as with standard models.
- The ZERO/ABS key allows the display to be zero-set at any slider position along the beam for incremental comparison measurements. This key will also allow return to the absolute coordinate with a display of the true position from the origin point.
- No rack, no pinion, no glass scale. Digimatic Scale Unit is safely embedded in the hardened stainless steel blade.
- Horizontal or vertical face according to the scale mounting direction.
- Multi-function types with diameter displaying function are also available (contact Mitutoyo) for lathes.
- All units come with two mounting brackets, each located at either end of the scale.
- With SPC data output.

ABSOLUTE™

Order No	Model	Range	Accuracy	Resolution	Type	List	Promo
572-210-20	SD-4"DX	0-4" / 0-100mm	.001" / 0.03mm	.0005" / 0.01mm	Horizontal single-function	\$235.00	\$223.25
572-211-20	SD-6"DX	0-6" / 0-150mm	.001" / 0.03mm	.0005" / 0.01mm	Horizontal single-function	\$249.00	\$236.55
572-212-20	SD-8"DX	0-8" / 0-200mm	.001" / 0.03mm	.0005" / 0.01mm	Horizontal single-function	\$290.00	\$275.50
572-213-10	SD-12"D	0-12" / 0-300mm	.002" / 0.04mm	.0005" / 0.01mm	Horizontal single-function	\$559.00	\$531.05
572-310-10	SD-6"D	0-4" / 0-100mm	.001" / 0.03mm	.0005" / 0.01mm	Vertical single function	\$260.00	\$247.00
572-311-10	SD-6"D	0-6" / 0-150mm	.001" / 0.03mm	.0005" / 0.01mm	Vertical single-function	\$276.00	\$262.20
572-312-10	SD-8"D	0-8" / 0-200mm	.001" / 0.03mm	.0005" / 0.01mm	Vertical single function	\$320.00	\$304.00
572-313-10	SD-12"D	0-12" / 0-300mm	.002" / 0.04mm	.0005" / 0.01mm	Vertical single function	\$616.00	\$585.20



Applications

Machine table position

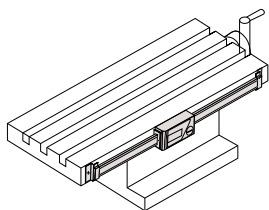

Drilling machine stroke position

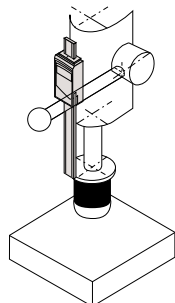

Focus setting on optical instruments

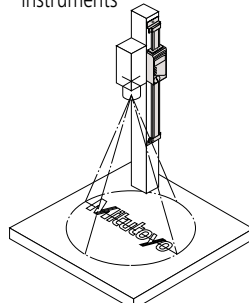

Special Applications

As a measurement jig for outdoor use (SD-G)

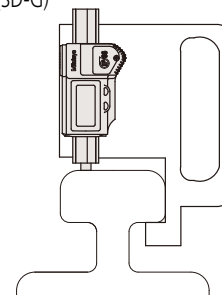

Detector head mechanism

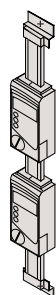

Litematic and Litematic Head

High-resolution Measuring Unit

Features

- The Litematic is designed for measuring any component, but especially easily-deformed workpieces and high-precision parts such as thin-wall bearings, plastic parts, and springs.
- Extra-low measuring force of 0.01N (1gf).
- Hands-free operation with optional foot switch.
- Ceramic anvil is free from corrosion and has superior wear-resistance.
- The Litematic Head unit can be mounted onto fixtures or an optional stand to allow flexibility of use.
- With SPC output.
- The motorized spindle automatically stops when it contacts the workpiece.



318-221A



318-226A



*The stand (No.957460) is sold as an option.

Order No.	Resolution	Range	Accuracy (at 20°C)	List	Promo
318-221A	.0000005", .000005", .00005"	0 - 2" (50mm)	(0.5 + L / 100)µm L=Measured length (mm)	\$8,480.00	\$7,632.00
318-226A	0.01µm, 0.1µm, 1µm	0 - 2" (50mm)	(0.5+L/100)µm L=Measured length (mm)	\$8,480.00	\$7,632.00
957460	Dedicated Stand for Model 318-226A*			\$4,370.00	\$3,930.00

TM Toolmakers' Microscopes

Features

- Angle measurement is performed easily by turning the angle scale disc to align the cross-hair reticle with the workpiece image.
- Illumination intensity can be adjusted.
- Included standard accessories create an overall magnification of 30X. Magnifications can be changed from 20 - 200X by using optional objectives and/or eyepieces.
- Newly designed LED illuminators provide enhanced observation for higher accuracy and resolution.



Conventional illumination



Newly designed LED illumination



TM-A505B
176-820A

Model No.	TM-505B	TM-A505B	TM-1005B	TM-A1005B	
Order No.	176-818A	176-820A	176-819A	176-821A	
Eyepiece	Standard accessory: 15X (field number: 13), Options: 10X, 20X				
Objective lens	Standard accessory: 2X, Options: 5X, 10X				
Microscope head	Maximum height of workpiece		4.53" / 115mm	4.21" / 107mm	
Illumination unit	Transmitted illumination				
	Stepless brightness adjustment, White LED light source, With green filter				
Cross-travel stage	Surface illumination		Oblique single-source type, Stepless brightness adjustment, White LED light source		
	Measuring range		2" x 2" / 50x50mm	4" x 2" / 100x50mm (An optional 2"/50mm gauge block is required to cover full range. A CERA block is recommended.)	
Cross-travel stage	Usable area of the stage glass		3.8" x 3.8" / 96x96mm	6" x 3.8" / 154x96mm	
	Maximum stage glass loading		11 lbs. / 5kg		
Linear measurement method	Micrometer heads optional	Micrometer heads included	Micrometer heads optional	Micrometer heads included	
	List	\$3,790.00	\$5,590.00	\$5,490.00	\$7,290.00
	Promo	\$3,411.00	\$5,031.00	\$4,941.00	\$6,561.00

Ultra-High Accuracy

Laser Scan Micrometer LSM-902/6900

Features

- High-accuracy inspection of pin and plug gages and other tight-tolerance parts such as medical and aerospace.
- Ultra-high accuracy: Linearity of $\pm 0.5\mu\text{m}$ for entire range.
- Statistical calculation mode.
- Ultra-high repeatability of $\pm 0.05\mu\text{m}$.
- RS-232C output, I/O interface are standard.



Bench Top

Laser Scan Micrometer LSM-9506

Features

- Integrated display and measuring unit into one unit.
- Statistical calculation mode.
- RS-232C output, I/O interface, and SPC output interface are standard.



Order Number	Range	Resolution	List	Promo
544-496A	.004" - 1.0"/0.1mm - 25mm	.000001" - .0005"/0.00001 - 0.01mm	\$12,200.00	\$10,980.00
544-116-1A	.020" - 2.36"/0.5mm - 60mm	.000002" - .005"/0.00005 - 0.1mm	\$8,940.00	\$8,046.00

Includes Quicktool, a free software package that makes operation of LSM setting simple and easy. For use with customer-supplied PC and RS-232C cable



www.mitutoyo.com/LSM
VIDEO DEMO

High-Accuracy Non-Contact Measuring Systems

Features

- Excellent linearity: down to ± 0.3 microns.
- High speed scanning capable: 3200 scans per second.
- Various ranges available for selecting the best laser for your application
- Statistical calculation mode.
- Includes Quicktool*, a free software package that makes operation of LSM setting simple and easy.
- Its memory function has been increased to allow storage of up to 100 programs.

*For use with customer supplied PC and RS-232C cable.

Package



SAVE UP TO 35%

LSM-6200 Display Unit Included

Order No	Model	Range Inch	Range mm	Repeatability	Linearity	Scanning Rate	List	Promo
64PKA117	LSM-500S	.0002" - .08"	0.005~2mm	$\pm 0.03\mu\text{m}$	$\pm 0.3\mu\text{m}$	3,200 scans/sec	\$10,370.00	\$7,090.00
64PKA118	LSM-501S	.002" - .4"	0.05~10mm	$\pm 0.04\mu\text{m}$	$\pm 0.5\mu\text{m}^\dagger$	3,200 scans/sec	\$9,330.00	\$6,050.00
64PKA119	LSM-503S	.012" - 1.18"	0.3~30mm	$\pm 0.11\mu\text{m}$	$\pm 1.0\mu\text{m}^\dagger$	3,200 scans/sec	\$10,110.00	\$6,830.00
64PKA120	LSM-506S	.04" - 2.36"	1~60mm	$\pm 0.36\mu\text{m}$	$\pm 3\mu\text{m}^\dagger$	3,200 scans/sec	\$11,480.00	\$8,200.00
64PKA121	LSM-512S	.04" - 4.72"	1~120mm	$\pm 0.85\mu\text{m}$	$\pm 6\mu\text{m}^\dagger$	3,200 scans/sec	\$17,680.00	\$14,400.00
64PKA122	LSM-516S	.04" - 6.30"	1~160mm	$\pm 1.4\mu\text{m}$	$\pm 7\mu\text{m}^\dagger$	3,200 scans/sec	\$28,480.00	\$25,200.00

[†]Linearity over entire range. Higher accuracies are possible over smaller ranges.

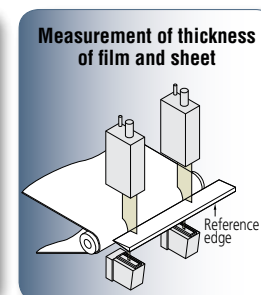
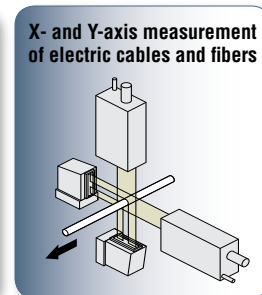
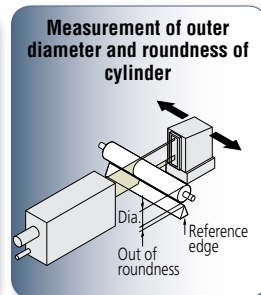
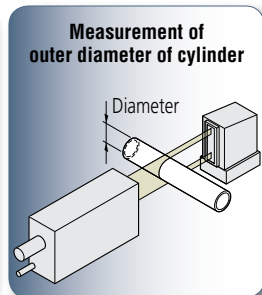
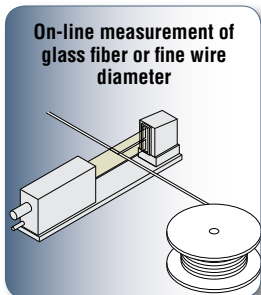

Prices effective May 1 through July 29, 2016

PH-3515F Horizontal Profile Projector

Features

- Heavy-duty, bench-top model with horizontal optical system.
- Erect image on day-bright screen.
- 14" (356mm) dia. protractor screen with crosshair line for easy alignment
- 10" x 6" floating-type workstage incorporates linear scales for fast, accurate measurement.
- Suitable for thread pitch measurements – free from blurred or distorted images when the workpiece is angled.
- Robust workstage provides high accuracy and can handle a workload up to 100 lbs.



QM-Data 200
264-156A
Included in
Package #
64PKA088A

Stand
(Not Shown)
64AAB176
(optional)

Order No.	Description	List	Package Price
64PKA088A	PH-3515F Profile Projector w/QM Data (Arm Mount)	\$13,500.00	\$12,825.00
64PKA089B	PH-3515F Profile Projector w/KA counter & tray	\$11,600.00	\$11,020.00
64AAB176	PH-3515 Stand (optional)	\$687.00	\$618.50

PJ-A3000 Vertical Profile Projector



PJ-A3010F-200

Features

- A series of midsize profile projectors featuring bright, 12.40" (315mm) diameter screens and easy-to-operate XY measurement tables.
- A floating table makes measuring quicker and easier.
- Built-in, easy-to-read digital counters are located near the projection screen, thereby minimizing strain associated with excessive movement.
- For edge-sensing capabilities, order the Optoeye-200, part number 332-151.

Order No.	Description	XY Range	List	Promo
302-701A	PJ-A3010F-200	8" x 4"	\$13,600.00	\$12,920.00
302-703A	PJ-A3010F-100	4" x 4"	\$10,800.00	\$10,260.00

Optional Accessories

Order No.	Description	List	Promo
264-156A	QM-Data 200	\$2,720.00	\$2,584.00
332-151	Optoeye 200	\$1,650.00	\$1,485.00
64PMI167	Stand for PJ-A3000	\$688.00	\$653.60
12AAA807	RS-232C Cable	\$54.30	\$51.60
12AAE671	Attachment board (A)	\$40.80	\$38.80

PH-A14 Horizontal Profile Projector

Features

- Mitutoyo's lens technology and workmanship combine to provide a bright, crisp image for error-free inspection.
- 8" x 4" floating-type workstage incorporates linear scales for fast, accurate measurement.
- The workstage provides high accuracy and can handle a workload of up to 100 lbs.
- 10x objective lens and fiber illuminator are standard accessories.



KA-200 Counter



QM Data

Order No.	Description	List	Promo
64PKA087	PH-A14 Profile Projector w/QM Data (Arm Mount)	\$8,290.00	\$7,875.00
64PKA086A	PH-A14 Profile Projector w/KA counter & tray	\$6,380.00	\$6,061.00
64AAA129B	PHA14 Stand (optional)	\$707.00	\$636.30
174-183A	KA-200 Counter	\$587.00	\$528.30

Rockwell Hardness Testers

The features-packed yet economical Rockwell and Rockwell Superficial Hardness Testers cover a large range of testing applications. These testers meet the current international requirements such as ASTM E18 and are designed for years of accurate results.

SAVE UP TO 20%

Model Order No.	HR-320MS 963-231-10A	HR-430-MR 963-240-10A	HR-430MS 963-241-10A
Rockwell	+	+	+
Rockwell Superficial	+	—	+
Light Force Brinell	Optional	Optional	Optional
Display Unit	Digital: Hardness value, Scale display, Timer setting, Conversion, go/no-go judgment, Offset setting		
Data Output	RS-232C SPC (Digimatic)		
Dial a Weight	—	+	+
Motorized Test Force Control	+	+	+
Automatic Brake/Start	—	+	+
List	\$8,740.00	\$9,000.00	\$10,000.00
Promo	\$6,990.00	\$7,990.00	\$8,990.00



Model: **HR-320MS**

- Rockwell/Rockwell Superficial
- Motorized test force control
- Test force selection manual by weight



Model: **HR-430MR**

- Rockwell
- Motorized test force control
- Dial a weight test force selection
- Auto brake/start



Model: **HR-430MS**

- Rockwell/Rockwell Superficial
- Motorized test force control
- Dial a weight test force selection
- Auto brake/start

Durometers (Digital and Analog)

For Rubber and Plastics Hardness Testing

Durometers are suitable for testing natural rubber, neoprene, polyesters, P.V.C., leather, Thiokol, nitril, wax, vinyl, cellulose acetates, glass, polystyrol and other materials.



Compact Dial
811-336-10



Compact Digital
811-336-10

Order No	Model	Scale	Display	Graduation	Range	Indenter	List	Promo
811-335-10	HH-335	Shore A	Analog	1.0	10~90	Blunt Taper	\$599.00	\$569.05
811-336-10	HH-336	Shore A	Digital	0.5	10~90	Blunt Taper	\$1,280.00	\$1,216.00
811-337-10	HH-337	Shore D	Analog	1.0	20~90	Sharp Point	\$599.00	\$569.05
811-338-10	HH-338	Shore D	Digital	0.5	20~90	Sharp Point	\$1,280.00	\$1,216.00
64AAA964	Test Block Set (Shore A Scale)						\$188.00	\$178.60
64AAA590	Test Block Set (Shore D Scale)						\$188.00	\$178.60
64AAA962	"A" Scale Durometer Stand						\$959.00	\$911.05
64AAA796	"D" Scale Durometer Stand						\$2,500.00	\$2,375.00



Multiplexers – MIG-8USB, MIG-4USB

Features

- A measurement data transfer device, multiplexer MIG-8USB and MIG-4USB converts digimatic output measurement data to USB or RS-232C and outputs it to an external device such as PC.
- Data can be sent directly into spreadsheets.

MeasurLink[®] ENABLED
Data Management Software by Mitutoyo



64AAB386
Front view



64AAB386
Back view

Model No.	MIG-8USB	MIG-4USB
Order No.	64AAB386	64AAB387
Gage Capacity	8	4
Dimension (mm) W x D x H	146 x 150 x 45	146 x 150 x 70
Mass (g)	540	710
List	\$1,340.00	\$830.00
Promo	\$1,206.00	\$747.00

Digimatic Mini-Processor Printer

Features

- This is a palm-sized printer used to print measurement data from the digimatic gage or to perform statistical analysis.
- This printer offers excellent functionality. You can use it not only to print measurement data, perform a variety of statistical analyses, and draw a histogram or D chart but also to perform complicated operations for X-R control chart.
- Equipped with RS-232C output and go/no-go judgment output as standard functions, this processor ensures high reliability as an advanced quality inspection machine.
- The line thermal printer enables fast and quiet printing.



264-504-5A

Order No.	Description	List	Promo
264-504-5A	DP - 1VR	\$506.00	\$480.70



Mitutoyo SPC Cables

Mitutoyo SPC cables for tools with Mitutoyo Digimatic SPC output.



Order No.	Length	Pins	For Use With	List	Promo
With Data Out Switch					
05CZA624	40"	—	IP66/67 Calipers	\$93.90	\$89.20
05CZA625	80"	—	IP66/67 Calipers	\$95.35	\$90.60
05CZA662	40"	—	IP65 Micrometers	\$83.80	\$79.60
05CZA663	80"	—	IP65 Micrometers	\$92.45	\$87.85
959149	40"	—	Height Gage 570 Series, Digimatic Indicator 543 and 575 Series, Digimatic Scale Unit 572 Series, Digimatic Absolute Calipers	\$49.25	\$46.80
959150	80"	—	Height Gage 570 Series, Digimatic Indicator 543 and 575 Series, Digimatic Scale Unit 572 Series, Digimatic Absolute Calipers	\$55.20	\$52.45
Without Data Out Switch					
937387	40"	6	Borematic 568 Series	\$50.85	\$48.30
965013	80"	6	Borematic 568 Series	\$60.10	\$57.10
905338	40"	—	Height Gage 570 Series, Digimatic Indicator 543 and 575 Series, Digimatic Scale Unit 572 Series	\$40.05	\$38.05
905409	80"	—	Height Gage 570 Series, Digimatic Indicator 543 and 575 Series, Digimatic Scale Unit 572 Series	\$47.75	\$45.35



IMTS2016

The Americas' Largest Manufacturing Show

The International Manufacturing Technology Show is one of the largest industrial trade shows in the world, featuring more than 2,000 exhibiting companies and 114,147 registrants. The event is held every two years.

September 12-17, 2016 | McCormick Place, Chicago

VISIT US AT BOOTH E-5215

© 2016 Mitutoyo America Corporation



Whatever your challenges are, Mitutoyo supports you from start to finish.

Mitutoyo is not only a manufacturer of top-quality measuring products but one that also offers qualified support for the lifetime of the equipment, backed by comprehensive services that ensure your staff can make the very best use of the investment.

Apart from the basics of calibration and repair, Mitutoyo offers product and metrology training, as well as IT support for the sophisticated software used in modern measuring technology. We can also design, build, test and deliver measuring solutions and even, if deemed cost-effective, take your critical measurement challenges in-house on a sub-contract basis.



Find additional product literature and our product catalog

www.mitutoyo.com

Distributed by:

Note: All information regarding our products, and in particular the illustrations, drawings, dimensional and performance data contained in this printed matter as well as other technical data are to be regarded as approximate average values. We therefore reserve the right to make changes to the corresponding designs. The stated standards, similar technical regulations, descriptions and illustrations of the products were valid at the time of printing. In addition, the latest applicable version of our General Trading Conditions will apply. Only quotations submitted by ourselves may be regarded as definitive. Specifications are subject to change without notice.

Mitutoyo products are subject to US Export Administration Regulations (EAR). Re-export or relocation of our products may require prior approval by an appropriate governing authority.

Trademarks and Registrations

Designations used by companies to distinguish their products are often claimed as trademarks. In all instances where Mitutoyo America Corporation is aware of a claim, the product names appear in initial capital or all capital letters. The appropriate companies should be contacted for more complete trademark and registration information.



Mitutoyo America Corporation

www.mitutoyo.com

One Number to Serve You Better

1-888-MITUTOYO (1-888-648-8869)

M³ Solution Centers:

Aurora, Illinois (Headquarters)

Boston, Massachusetts

Huntersville, North Carolina

Mason, Ohio

Plymouth, Michigan

City of Industry, California

Birmingham, Alabama

Renton, Washington

Houston, Texas